

www.xcmg.com

QUY400履带起重机 QUY400 CRAWLER CRANE

本印刷品所包含的数据，会随着产品的不断升级而改变，请以实际产品为准
Pictures and data in this catalog will change with the update and modification of products, so please take the actual vehicle as reference.

徐工集团 工程机械股份有限公司建设机械分公司

XCMG, CONSTRUCTION MACHINERY CO., LTD. BUILDING MACHINERY CO.

地址：江苏省徐州市桃山路19号

邮编 (Post Code) : 221002

Add: No.19 Taoshan Road, Xuzhou, Jiangsu Province, China

销售电话 (Sales Tel) : 0516-87892099 0516-87892534 销售传真 (Sales Fax) : 0516-87892015

服务/备件电话 (Service/Spare Parts Tel) : 0516-87892088 0516-87892510

服务/备件传真 (Service/Spare Parts Fax) : 0516-87892506

质量监督电话 (Quality Inquiry Tel) : 0516-87892503

请垂询

CONTACT

QUY400履带起重机

QUY400 CRAWLER CRANE



 徐工集团 工程机械股份有限公司建设机械分公司

XCMG, CONSTRUCTION MACHINERY CO., LTD. BUILDING MACHINERY CO.

技术性能参数/整机基本尺寸 Technical Specification/Overall Dimension

主要零部件 Main Parts

目录 CONTENTS

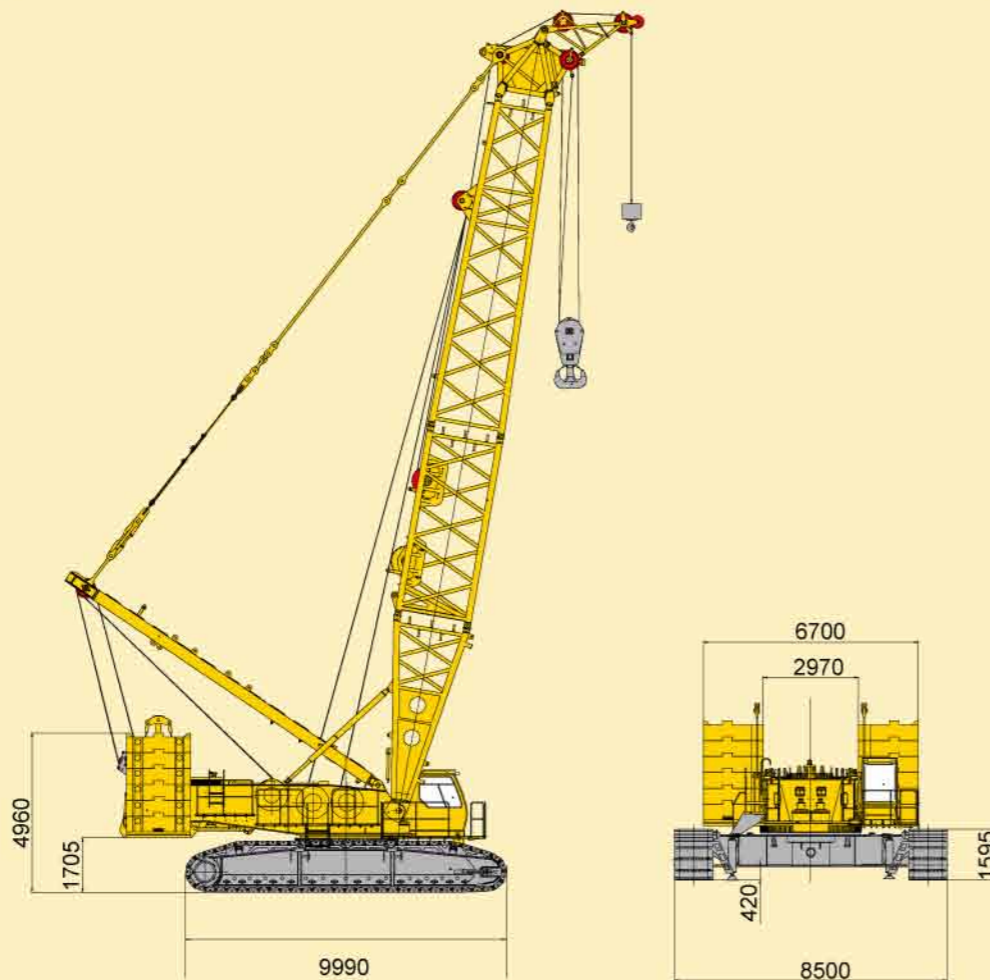

- 主要零部件 Main Parts 1
- 详细介绍 Brief Introduction 6
- 自拆装 Self Assembly & Disassembly 10
- 工况示意图 Working Mode Illustration 11
- 标准工况重型主臂臂节组合/重型主臂 Standard Mode Heavy Boom Combinations/Heavy Boom 13
- 标准工况重型主臂作业范围 Standard Mode Heavy Boom Working Area 14
- 标准工况重型主臂载荷表 Standard Mode Heavy Boom Lifting Load Chart 15
- 标准工况轻型主臂臂节组合/轻型主臂 Standard Mode Light Boom Combinations/Light Boom 16
- 标准工况轻型主臂作业范围 Standard Mode Light Boom Working Area 17
- 标准工况轻型主臂载荷表 Standard Mode Light Boom Lifting Load Chart 18
- 标准工况固定副臂臂节组合/固定副臂 Standard Mode Fixed Jib Combinations/Fixed Jib 19
- 标准工况固定副臂作业范围 Standard Mode Fixed Jib Working Area 20
- 标准工况重型主臂 + 固定副臂载荷表 Standard Mode Heavy Boom + Fixed Jib Lifting Load Chart 21
- 标准工况专用副臂臂节组合/专用副臂 Standard Mode special Jib Combinations/special Jib 25
- 标准工况专用副臂作业范围 Standard Mode special Jib Working Area 26
- 标准工况塔式副臂臂节组合/塔式副臂 Standard Mode Tower Jib Combinations/Tower Jib 27
- 标准工况塔式副臂作业范围 Standard Mode Tower Jib Working Area 28
- 标准工况塔式副臂载荷表 Standard Mode Tower Jib Lifting Load Chart 29
- 超起工况重型主臂 SL Mode Heavy Boom 34
- 超起工况重型主臂作业范围 SL Mode Heavy Boom Working Area 35
- 超起工况重型主臂载荷表 SL Mode Heavy Boom Lifting Load Chart 36
- 超起工况轻型主臂 SL Mode Light Boom 38
- 超起工况轻型主臂作业范围 SL Mode Light Boom Working Area 39
- 超起工况轻型主臂载荷表 SL Mode Light Boom Lifting Load Chart 40
- 超起工况塔式副臂 SL Mode Tower Jib 42
- 超起工况塔式副臂作业范围 SL Mode Tower Jib Working Area 43
- 超起工况塔式副臂载荷表 SL Mode Tower Jib Lifting Load Chart 44

项目 Items	单位 Unit	数值 Data	
最大起重量 Max. lifting capacity	t	400	
最大起重力矩 Max. load moment	t.m	超(SL)5152/标(Standard)2380	
标准工况 Standard mode	重型主臂长度 Heavy boom length	m	24~84
	轻型主臂长度 Light boom length	m	42~102
	固定副臂长度 Fixed jib length	m	12~36
	专用副臂长度 special jib length	m	12~18
	塔式副臂长度 Tower jib length	m	24~72
超起工况 SL mode	重型主臂长度 Heavy boom length	m	36~84
	轻型主臂长度 Light boom length	m	78~120
	塔式副臂长度 Tower jib length	m	24~72
最大单绳起升速度 Winch max. single line speed	m/min	130	
主臂变幅最大单绳速度 Boom luffing winch max. single line speed	m/min	2×44	
塔臂变幅最大单绳速度 Tower jib luffing winch max. single line speed	m/min	110	
超起变幅最大单绳速度 SL luffing winch max. single line speed	m/min	110	
回转速度 Slewing speed	r/min	1.1	
行走速度 Travel speed	km/h	1.3	
平均接地比压 Mean ground pressure	MPa	0.13	
发动机功率 Engine output power	kW	310	
整机重量 (24m重型主臂、400t吊钩) Total vehicle mass (24m heavy boom, 400t main hook block)	t	325	
最大单件 (主机) 运输重量 Max. weight of single unit (basic machine) in travel configuration	t	55	
最大单件 (主机) 运输尺寸 (长×宽×高) Max. dimension of single unit (basic machine) in travel configuration (L×W×H)	m	10.36×3.39×3.0	





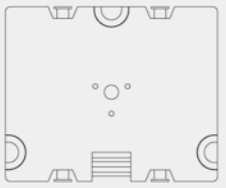
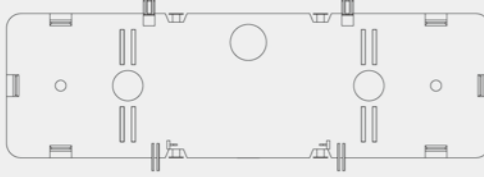

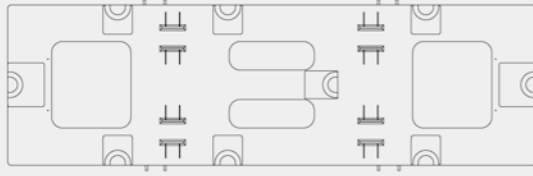
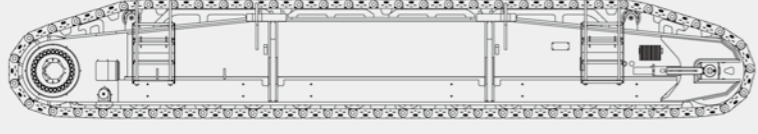
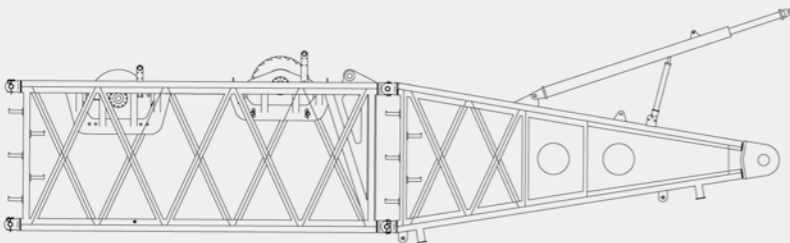
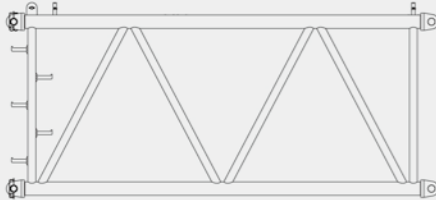
	主机 Basic Machine × 1 长L 10360mm 宽W 3390mm 高H 3000mm 重量 Weight 55000kg
	400t吊钩 Capacity Hook Block × 1 长L 2200mm 宽W 1000mm 高H 2100mm 重量 Weight 7500kg
	150t吊钩 Capacity Hook Block × 1 长L 1200mm 宽W 900mm 高H 1500mm 重量 Weight 4500kg
	100t吊钩 Capacity Hook Block × 1 长L 1200mm 宽W 900mm 高H 1500mm 重量 Weight 3900kg
	50t吊钩 Capacity Hook Block × 1 长L 920mm 宽W 600mm 高H 1300mm 重量 Weight 1700kg
	12t吊钩 Capacity Hook Block × 1 长L 1100mm 宽W 600mm 高H 600mm 重量 Weight 920kg
	上车平衡重块 Upper Counterweight × 12 长L 2000mm 宽W 1965mm 高H 566mm 重量 Weight 9500kg
	下车平衡重块 Lower Counterweight × 4 长L 2180mm 宽W 1800mm 高H 356mm 重量 Weight 6800kg

主要零部件 Main Parts

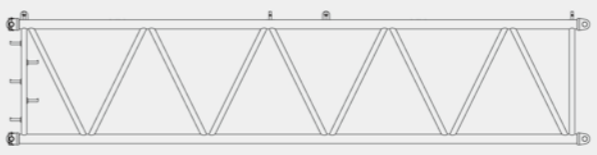
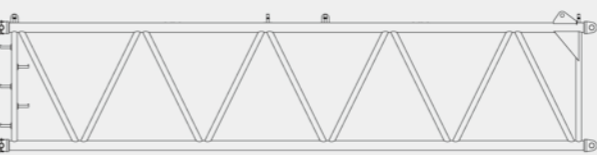
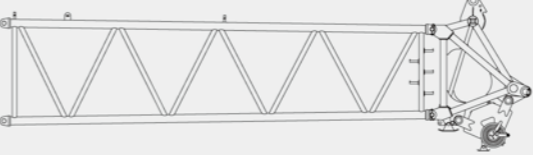
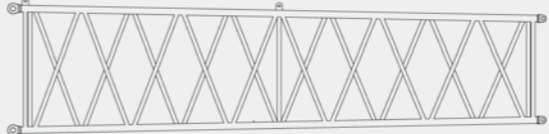
	超起平衡重块 SL Counterweight × 19 长 L 2180mm 宽 W 1800mm 高 H 478mm 重量 Weight 10000kg
	上车平衡重托盘 Upper Counterweight Tray × 2 长 L 6700mm 宽 W 2410mm 高 H 1780mm 重量 Weight 25000kg
	车身配重箱 Car-body Counterweight Box × 2 长 L 2100mm 宽 W 2340mm 高 H 850mm 重量 Weight 1334kg
	超起平衡重托盘 SL Counterweight Tray × 1 长 L 7200mm 宽 W 2180mm 高 H 1300mm 重量 Weight 10000kg
	履带架 Crawler × 2 长 L 9980mm 宽 W 1500mm 高 H 1600mm 重量 Weight 31000kg
	主臂6m底节臂+6m卷扬节 (含塔臂变幅卷扬和单滑轮起升卷扬) Boom Butt + Winch Section (include tower jib luffing winch and single sheave hoisting winch) × 1 长 L 12550mm 宽 W 2800mm 高 H 2900mm 重量 Weight 7900kg
	主臂6m中间节 Boom Insert × 2 长 L 6200mm 宽 W 2800mm 高 H 2700mm 重量 Weight 2300kg

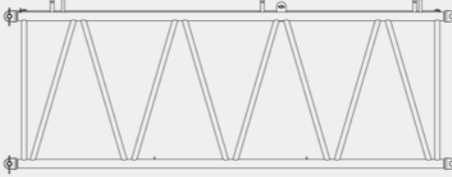
主要零部件 Main Parts

	主臂12m中间节 Boom Insert × 3 长 L 12200mm 宽 W 2800mm 高 H 2700mm 重量 Weight 4100kg
	主臂12m拉板节 Boom Pendant Section × 1 长 L 12200mm 宽 W 2800mm 高 H 2700mm 重量 Weight 4500kg
	主臂10.5m锥节臂+臂头 Boom Taper Section + Boom Head × 1 长 L 10700mm 宽 W 2800mm 高 H 2900mm 重量 Weight 9100kg
	10.5m轻型过渡节 Light Boom Extension × 1 长 L 10710mm 宽 W 2760mm 高 H 2900mm 重量 Weight 2620kg
	塔臂底节臂 Tower Jib Butt × 1 长 L 4710mm 宽 W 2250mm 高 H 2250mm 重量 Weight 2120kg
	塔臂6m中间节 Tower Jib Insert × 2 长 L 6140mm 宽 W 2250mm 高 H 1950mm 重量 Weight 1200kg
	塔臂12米中间节 Tower Jib Insert × 4 长 L 12140mm 宽 W 2250mm 高 H 1950mm 重量 Weight 2200kg

主要零部件 Main Parts

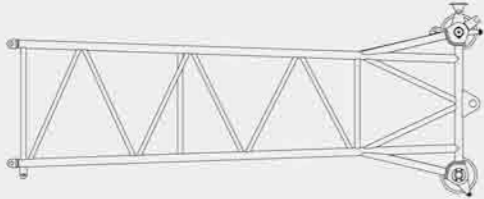
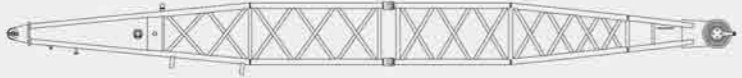
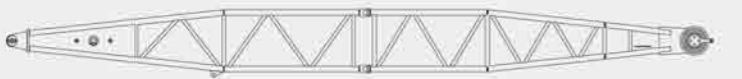
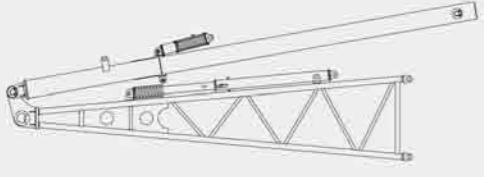
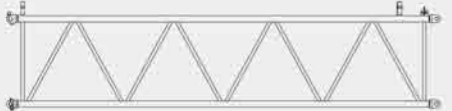
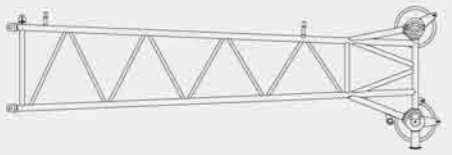
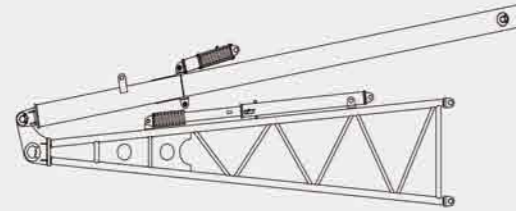
	塔臂顶节臂 Tower Jib Top × 1 长 L 8100mm 宽 W 2440mm 高 H 2730mm 重量 Weight 3421kg
	塔臂前支架 Tower Jib Front Strut × 1 长 L 13010mm 宽 W 1600mm 高 H 1600mm 重量 Weight 3050kg
	塔臂后支架 Tower Jib Rear Strut × 1 长 L 12100mm 宽 W 1600mm 高 H 1600mm 重量 Weight 2700kg
	固定副臂底节臂(含支架及前后防倾杆) Fixed Jib Butt(include strut and front/rear backstop) × 1 长 L 6290mm 宽 W 1610mm 高 H 1320mm 重量 Weight 2275kg
	固定副臂中间节 Fixed Jib Insert × 4 长 L 6100mm 宽 W 1540mm 高 H 1500mm 重量 Weight 592kg
	固定副臂顶节臂 Fixed Jib Top × 1 长 L 6420mm 宽 W 1520mm 高 H 2110mm 重量 Weight 1380kg
	专用副臂底节臂 Special Jib Base × 1 长 L 6290mm 宽 W 1610mm 高 H 1320mm 重量 Weight 855kg

主要零部件 Main Parts

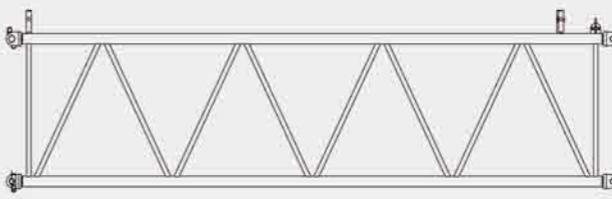
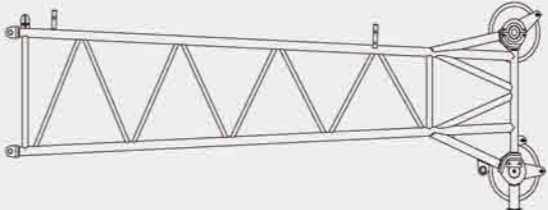
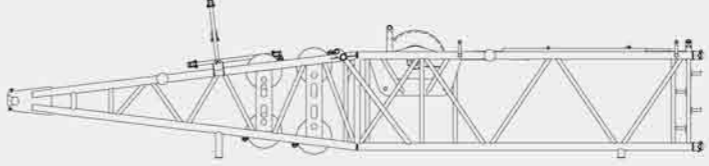
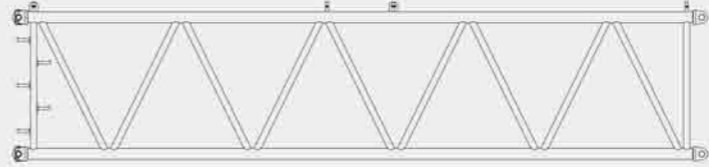
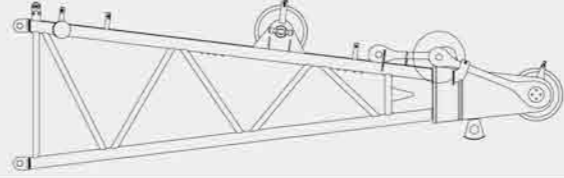
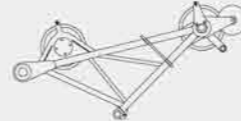
	专用副臂中间节 Special Jib Insert × 1 长 L 6100mm 宽 W 1540mm 高 H 1500mm 重量 Weight 592kg
	专用副臂顶节臂 Special Jib Top × 1 长 L 6422mm 宽 W 1520mm 高 H 2110mm 重量 Weight 1380kg
	超起桅杆底节臂(含超起变幅卷扬) SL Mast Butt(include SL luffing winch) × 1 长 L 12200mm 宽 W 2900mm 高 H 2800mm 重量 Weight 10305kg
	超起桅杆12m中间节 SL Mast Insert × 1 长 L 12200mm 宽 W 2900mm 高 H 2000mm 重量 Weight 2400kg
	超起桅杆顶节臂 SL Mast Top × 1 长 L 6400mm 宽 W 2200mm 高 H 2000mm 重量 Weight 2700kg
	臂端单滑轮 Boom Head Single Sheave × 1 长 L 2812mm 宽 W 1540mm 高 H 1890mm 重量 Weight 605kg

说明 Notes

- 以上零部件运输形状为示意图，所标尺寸为设计值，不包括包装。
The above parts dimension is only for illustration, the dimension shown is design value, and does not include the package.
- 重量为设计值，由于制造误差，可能稍有不同。
The weight is design value, may have slight difference due to error in manufacture.

详细介绍 Detailed Introduction

上车

发动机

QUY400选用进口沃尔沃的直列6缸、水冷、增压、中冷电喷环保型发动机，额定功率310KW，额定转速2100rpm，最大输出扭矩2000N·M符合欧洲工程机械II号排放标准，它具有结构紧凑、体积小、重量轻、功率大、油耗低、污染小、工作可靠、寿命长等显著特点，能满足履带起重机的各种工况。

控制系统

采用PLC程序控制，以保证液压系统的先导控制、力矩限制、高度限位等功能的实现，确保起重机安全可靠地运行。

液压系统

采用电比例控制，开闭式回路相结合，恒功率变量泵系统。
液压系统组成：起升回路、变幅回路、回转回路、防后倾回路、行走回路以及辅助安装回路。
特点：起升回路、变幅回路、行走回路采用开式泵控系统。主泵为恒功率变量泵，电比例液压先导控制变量，可以同时满足多个执行元件动作要求。回转系统采用闭式系统，响应迅速，控制精准，开启和制动时动作平稳，且换向时无冲击。可以满足频繁换向和微动操作要求。

起升机构

主起升机构有两个，型号相同，单独驱动，大起重量时两个卷扬同步工作。卷扬采用片式常闭制动器，内藏式减速机，变量马达驱动。两个主起升机构共用一个整体式支架，与转台采用销轴连接，便于组装。副起升机构和主起升相同，用于臂端单滑轮的起升。钢丝绳均为德国进口不旋转钢丝绳，避免了钢丝绳打绞。

变幅机构

主臂变幅为一个双联卷筒独立驱动，塔臂变幅和超起变幅均为单卷扬独立驱动。主、副变幅机构采用内藏式减速机，片式常闭制动器。卷筒设有棘轮装置，以实现机械锁止制动，安全可靠。驱动马达、平衡阀、钢丝绳均为德国进口。

回转机构

布置在转台内侧前面，由两个行星减速机组成，与回转支承外啮合，液压缓冲，具有自由滑转功能。行星减速机，可控常闭、片式制动器，工作可靠，维修方便。

回转支承

采用徐州罗特艾德公司的三排滚柱式回转支承，质量稳定可靠。

平衡重系统

平衡重系统包括转台平衡重、超起平衡重、车身平衡重。

转台平衡重： 140t
平衡重托盘1件 25t/件
平衡重块12件 9.5t/件
超起平衡重： 200t
平衡重底座1件 10t/件
平衡重块19件 10t/件
车身平衡重： 30t
平衡重箱2件 1.3t/件
平衡重块4件 6.85t/件

Crane Superstructure

Engine

QUY400 uses VOLVO TWD1240VE diesel engine, 6-cylinder of water-cooled, turbocharged, inter-cooled and electronic injection, rated output power 310kW, rated speed 2100rpm, max. output torque 2000N.m, emission in compliance with European Construction Machinery Stage II. It features compact structure, small size, light weight, strong power, low fuel consumption, little pollution, reliable work and long service life, can meet various working conditions for crawler cranes.

Control System

Adoption of PLC program control, to guarantee the realization of the hydraulic system functions of pilot control, load moment limit, hoist height limit, to ensure the safety and reliability for crane operation.

Hydraulic System

Electronic proportional control, with combination of close/open type circuit, constant power and variable displacement pump system.
Hydraulic system: winch, luffing gear, slewing gear, tower jib backstop, travel gear, auxiliary assembly system.
Features: winch, luffing gear, travel gear are of open type pump control system, main pump is constant power and variable displacement pump, electronic proportional hydraulic pilot controlled variable displacement, can meet the requirement of multiple actuator movement. Slewing gear is close type system, quick response, accurate control, stable starting and braking, and no impact for direction change, may satisfy operation of frequent direction change and fine motion control.

Winch

Two main winches of same model, with independent drive, and two winches synchronize for heavy load lifting; disc type constant closed brake, built-in speed reducer and variable displacement motor drive; two winches share one integrated bracket, and connected with turntable by pin shaft, easy for assembly. Auxiliary winch is the same as main winch, and used for boom head single sheave lifting. Winch wire rope is imported from Germany, no-twisting and no-turning.

Luffing Gear

Boom luffing gear is a twin drum independent drive unit, tower jib luffing gear and SL luffing gear is single winch independent drive unit. Main/auxiliary luffing gears use built-in speed reducer and disc type constant closed brake. The winch drum has a ratchet locking device to realize mechanical locking the boom, working safe and reliable. Drive motor, counterbalance valve, winch wire rope are all imported from Germany.

Slewing Gear

Slewing gear is arranged inside the front of turntable, made up by two planetary reducers, and internal meshed with slewing ring, hydraulic buffering, and with the function of free swing. Planetary reducer has a controllable constant-closed disc brake, reliable working and easy for maintenance.

Slewing Ring

Slewing ring is a 3-row roller type slewing bearing made by Xuzhou Rothe Erde, with reliable quality.

Counterweight System

Counterweight system consists of turntable counterweight, SL counterweight and car-body counterweight.
Turntable Counterweight: 140t
Counterweight tray 1 pcs. 25t/pcs.
Counterweight 12 slabs 9.5t/slab
SL Counterweight: 200t
Counterweight base 1 pcs. 10t/pcs.
Counterweight 19 slabs 10t/slab
Car-body Counterweight: 30t
Counterweight box 2 pcs. 1.3t/pcs.
Counterweight 4 slabs 6.85t/slab

详细介绍 Detailed Introduction

操纵室

操纵室采用钢制框架结构，正面配置有整体式夹层玻璃，其余玻璃均为钢化玻璃。装有可调式座椅、按人机工程学布置的全套操纵仪表和控制装置，配置冷暖空调、音响、灭火装置、闭路监视系统等，宽敞舒适。工作时，操纵室可调整俯仰角度，扩大视野，方便操作；运输时，操纵室可从侧方转到前方，减小运输宽度。

转台

转台是联系上下车的关键承载结构件，采用高强度钢板焊接而成的双侧“工”字梁框架复合结构，整体稳定性好。转台通过回转支承与下车进行联接。驾驶室、起升机构、变幅机构、发动机、桅杆、主臂及配重等分别与转台在不同部位进行联接。

下车

下车包括车架、履带架、行走机构和车身配重。车架和履带架采用销轴铰接式连接，销轴安装通过液压缸完成，履带架的拆装则可利用本机的桅杆油缸吊装。

车架

车架采用高强度钢板、箱形结构，中间设置横隔板，加强其抗扭刚度，结构简单，承载能力强，刚性好。

履带架

包括履带梁和四轮一带。履带梁采用箱形结构，和车架连接部位局部加强，中间设置横隔板。两个履带架对称设置，装有宽度为1.5m履带板，可同步操作，也可单独操纵，以实现直行和转弯。

行走机构

履带行走驱动采用德国进口的内藏式行星齿轮减速机，液压释放行走制动器，减速机由德国进口的轴向柱塞变量马达驱动。

行走速度

变量泵及变量马达可以实现高、低速两档无级变速，最高速度1公里/小时。行走时，设备运行平稳，可实现快速行走。

作业装置

起重臂包括主臂、固定副臂和塔式副臂。结构型式为中间等截面，两端变截面的四弦杆空间桁架结构，主弦杆采用进口高强度管材，腹杆采用国产优质管材，提高了臂架抗弯曲的能力。

工况

标准工况重型主臂工况
标准工况轻型主臂工况
标准工况固定副臂工况
标准工况专用副臂工况
标准工况塔式副臂工况
超起工况重型主臂工况
超起工况轻型主臂工况
超起工况塔式副臂工况

Operator's Cabin

Operator's cabin is steel frame structure, front windshield has overall type safety glass, other glass is hardened glass, equipped with adjustable seat, all kinds of ergonomic designed instruments and controls, vent type air-conditioner, CD player, fire extinguisher, and closed circuit monitoring system, spacious and comfortable. When the crane is in operation, the operator's cabin can be tilted upward to widen the field of vision. When the crane is in transportation, the operator's cabin can be turned from the side to the front so as to reduce the transport width.

Turntable

Turntable is key structural part linked with crane superstructure and crane carrier for load bearing, made of high strength steel plate and welded as compound structure of both sides "I"-shaped beam frame, with excellent stability. Turntable is connected with crane carrier by slewing ring, and many mechanisms arranged on it, such as operator's cabin, winch, luffing gear, engine, gantry, mast, boom and counterweight.

Crane Carrier

Crane carrier comprises car-body, crawler track, travel gear and superstructure counterweight. Car-body and crawler are articulated by pin shaft, the installation of pin shaft is realized by hydraulic cylinder, and the crane mast cylinder is used for crawler track assembly and disassembly.

Car-body

Car-body is made of high strength steel, box-type structure, with cross panel installed in the middle to strengthen its stiffness of torsion resistance, simple structure, high loading capacity and well rigidity.

Crawler Track

Crawler track consists of track beam, drive sprocket, idler wheel, upper roller, lower roller and track pads. Crawler beam is box-type structure, the connection place to frame is strengthened partially, and cross panel is installed in the middle of it. Two crawler tracks are symmetrically arranged, with track pads of 1.5m, can be operated synchronously or independently to realize straight travel and turning around.

Travel Gear

Travel gear drive has German imported built-in planetary gear reducer and hydraulic release service brake, the speed reducer is driven by German imported axial piston variable displacement motor.

Travel Speed

Variable displacement pump and variable displacement motor can realize high/low two kinds of infinitely variable speed drive, max. speed 1 km/h, stable and fast travel.

Lifting Operation Parts

Lifting boom comprises main boom, fixed jib and tower jib, the structural type is lattice structure of four tubular chords with intermediate equal section and two end variable section; the main boom chord is made of imported high quality tube, and web rod is made of domestic high quality tube, with the ability for improving torsion resistance.

Working Conditions

Standard Mode Heavy Boom Working Conditions
Standard Mode Light Boom Working Conditions
Standard Mode Fixed Jib Working Conditions
Standard Mode special Jib Working Conditions
Standard Mode Tower Jib Working Conditions
SL Mode Heavy Boom Working Conditions
SL Mode Light Boom Working Conditions
SL Mode Tower Jib Working Conditions

详细介绍

Detailed Introduction

主臂

主臂为中间等截面、两端变截面的空间桁架式结构，钢管焊接，臂架顶部与根部用钢板加强，以利于传递载荷。主臂配置臂端单滑轮机构，主臂长度为24~84m。

组成：底节臂6m、6m卷扬节×1、6m中间节臂×2、12m中间节臂×3、12m拉板节×1、10.5m过渡节及1.5m臂头。

固定副臂

固定副臂为中间等截面、两端变截面的空间桁架式结构，钢管焊接，臂架顶部与根部用钢板加强，以利于传递载荷。

固定副臂可在主臂长36~72米范围内进行作业，其作业长度为12~36m，含10°及30°两种安装角。

固定副臂通过支架及固定副臂前、后拉板与主臂连为一体，随着主臂变幅机构的起与落来达到固定副臂的工作幅度。固定副臂支架结构为A形双肢箱形结构，抗轴压稳定性好，该支架长度为7m。

组成：底节臂6m、中间节臂6m×4、顶节臂6m。

专用副臂

专用副臂为中间等截面，两端变截面的空间桁架式结构，钢管焊接，臂架顶部与根部采用钢板加强，以利于传递载荷。

专用副臂可在主臂长72~78m范围内作业，其作业长度为12m和18m，10°安装角。

专用副臂通过支架及专用副臂前后拉板与主臂连为一体，随着主臂变幅机构的起与落来达到专用副臂的工作幅度。专用副臂支架结构为A形双肢箱形结构，抗轴压稳定性好，该支架长度为7m。

组成：底节臂6m，中间节臂6m，顶节臂6m。

塔式副臂

塔式副臂为中间等截面、两端变截面的空间桁架式结构，钢管焊接，臂架顶部与根部用钢板加强，以利于传递载荷。

塔式副臂可在主臂长30~72米范围内进行作业，其作业长度为24~72m。组成：底节臂4.5m、中间节臂6m×2、中间节臂12m×4、顶节臂7.5m。

桅杆

桅杆结构为箱形双肢结构,该结构整体稳定性好。在自拆装时，可组成桅杆吊，用于拆装整机的大型结构件。

吊钩

标准配置：400t吊钩、150t吊钩、100t吊钩、50t吊钩、12t吊钩

注：400t吊钩可以分解成2个200t吊钩

安全装置

安全装置包括力矩限制器、转台回转锁销装置、起重臂防后翻装置、起升高度限位装置、风速仪、水平仪、液压系统的溢流阀、平衡阀、双向液压锁、回转警告、行走警告等。

应急功能

系统程序崩溃时，可采用控制柜中的翘板开关把整机操作到安全状态。此时所有安全保护功能不起作用。

Main Boom

Main boom is lattice structure of intermediate equal section and two end variable section, welded by steel tube, boom top and boom foot reinforced by steel plate for load transfer. Main boom is equipped with boom head single sheave, and main boom length is 24~84m.

Construction: 6m boom butt, 6m×1 winch section, 6m×2 boom insert, 12m×3 boom insert, 12m×1 pedant section, 10.5m boom extension, and 1.5m boom head.

Fixed Jib

Fixed jib is lattice structure of intermediate equal section and two end variable section, welded by steel tube, jib top and jib foot reinforced by steel plate for load transfer.

Fixed jib can be operated within the range of boom length 36~72m, and lifting operation length is 12~36m, with two offset angle of 10° and 30°.

Fixed jib is integrated with boom by fixed jib strut and fixed jib front/rear pedant, and reaches the working radius with boom luffing gear raising and lowering. Fixed jib strut is A-shaped two limb box-type structure, with good stability for anti-axial pressure, and fixed jib strut length is 7m.

Construction: 6m jib butt, 6m×4 jib insert, 6m jib top.

Special Jib

Special jib is lattice structure of intermediate equal section and two end variable section, welded by steel tube, jib top and jib foot reinforced by steel plate for load transfer.

Special jib can be operated within the range of boom length 72~78m, and lifting operation length is 12m and 18m, with offset angle of 10°.

Special jib is integrated with boom by special jib strut and special jib front/rear pendant, and reaches the working radius with boom luffing gear raising and lowering. Special jib strut is A-shaped two limb box-type structure, with good stability for anti-axial pressure, and special jib strut length is 7m.

Construction: 6m jib butt, 6m jib insert, 6m jib top.

Tower Jib

Tower jib is lattice structure of intermediate equal section and two end variable section, welded by steel tube, jib top and jib foot reinforced by steel plate for load transfer.

Tower jib can be operated within the range of boom length 30~72m, and lifting operation length is 24~72m.

Construction: 4.5m jib butt, 6m×2 jib insert, 12m×4 jib insert, 7.5m jib top.

Mast

The mast is box-type structure of twin tubular chord, with good overall stability. When carrying out crane assembly/disassembly, the mast can be combined with other lifting parts for mounting and removing large crane structural parts.

Hook Block

Standard equipment: 400t capacity hook block, 150t capacity hook block, 100t capacity hook block, 50t capacity hook block, and 12t capacity hook block.

Note: 400t capacity hook block may be divided into two 200t capacity hook blocks.

Safety Device

Safety devices comprise: load moment limiter, turntable lock pin, boom backstop, hoist limit switch, anemometer, level gauge, hydraulic overflow valve, counterbalance valve, two-way hydraulic lock, slewing warning lamp and travel warning lamp, etc.

Emergency Function

When a breakdown occurs in the system, a toggle switch on control panel may be used to control the whole machine into safe state, at this time all safe protections have no use.

详细介绍

Detailed Introduction

力矩限制器

检测功能：力矩限制器能自动检测出起重臂的角度、起重载荷，

显示功能：实时的显示当前实际载荷，工作半径，起重臂角度。

警示功能：如果检测到实际载荷超过额定载荷，起重臂超过极限角度，力矩限制器发出报警并限制当前动作。

主、副提升过卷装置

当主、副卷扬起升到一定高度时候，仪表板上的过卷保护指示灯亮，同时力矩限制器停止起升升动作。

主、副提升过放装置

此保护功能由安装在卷筒内部接近开关检测到卷筒上的钢丝绳剩下三圈时候，仪表板上的指示灯亮，同时力矩限制器自动停止起升落动作。

安全保护开关

该安全保护开关放在手柄前侧，此开关没有按下的时候，所有动作信号被屏蔽，手柄不起作用。防止上下车身体碰撞手柄产生误操作。

棘爪锁止装置

该功能用于锁定变幅卷扬，起重臂降落的时候必须打开该装置，否则不能降落，用于保护臂架在非工作时安全停放。

起重臂角度限制

主起重臂仰角在85°时，起重臂被停止起升，由力矩限制器和行程开关双级控制。主起重臂在仰角小于30°时停止起升卷扬，由力矩限制器控制。塔臂由限位开关控制上限位和下限位。

监控系统

由4个摄像头和一个监视器组成，分别监视2个主变幅卷扬、主起升卷扬、塔臂变幅卷扬、单滑卷扬、超起桅杆卷扬。

声光报警器

在履带起重机行走或做回转动作的时候灯闪烁并且发出声音报警。

力限器三色报警灯

由三种颜色组成，负载在90%以下时“绿灯”亮，表示起重机在安全区域运行，负载在90%-100%的时候“黄灯”亮，表示起重机在已接近额定载荷范围，负载在100%-105%以上时“红灯”和“黄灯”同时亮，表示起重机已经超载。在危险区域，控制系统自动切断起重机向危险的方向运行。

照明灯

装置在转台前方、臂架上和操纵室内，用于夜间工作提供照明。

示高灯

安装在臂架顶部，作为高空警示。

风速仪

实时检测当前风速，传送到操纵室的监视器上，提醒司机操作的安全性。

说明

●各机构均为国际化配套，选用的是国内外知名厂家产品。

Load Moment Limiter

Detection function: automatically detect boom angle and lifting load.

Display function: real time display current actual load, working radius and boom angle.

Warning function: automatically send out warning and stop crane operation when detecting actual load exceed total rated load and boom out of limit angle.

Main/Auxiliary Winch Over-Wound Protection Device

When main/auxiliary winch hoists up to a certain lifting height, an over-wound warning lamp on instrument panel lights on, at the same time, load moment limiter stops crane hoisting up operation.

Main/Auxiliary Winch Over-Release Protection Device

When access switch in winch drum detects only three turns of wire rope left on the drum, an over-release warning lamp on instrument panel lights on, at the same time, load moment limiter stops crane hoisting up operation.

Safe Protection Switch

At the front of joystick installed a safe protection switch, when the switch is pressed down, all crane movement signals have been shielded, and the joystick is useless. This switch can be used to prevent malfunction when operator accessing the cabin and toughing the joystick.

Winch Ratchet Locking Device

Winch drum has a ratchet locking device, and it must be turned on when lowering boom, otherwise boom cannot be lowered. The device is used to stow the boom for safety.

Boom Angle Limit

When boom angle is more than 85°, both load moment limiter and hoist limit switch stop boom raising. When boom angle is less than 30°, load moment limiter stops boom lowering and give a sound warning. The hoist limit switch and load moment limiter may control the tower jib upper/lower limit position.

Monitor System

The monitor system contains 4 cameras and 1 monitor display, respectively keeping watch on 2 main luffing winches, main hoisting winch, tower jib luffing winch, single sheave hoisting winch, and SL mast winch.

Audio/Video Warning

When crawler crane is moving and slewing, there is light and sound for warning.

Tricolor Warning Lamp

The lamp comprises 3 colors, when crane loading is below 90% of total rated lifting load, "Green Lamp" lights on to indicate crane is running in safety area; when crane loading is in 90%~100% of total rated lifting load, "Yellow Lamp" lights on to indicate crane is close to total rated lifting load; when crane loading is above 100%~105% of total rated lifting load, "Red Lamp" and "Yellow Lamp" light on at the same time to indicate crane is overload; In dangerous area, control system can automatically cut off crane movement to dangerous direction.

Illumination Lamp

There are illumination lamps at front of turntable, on boom and inside operator's cabin for night operation.

Height Mark Lamp

Boom tip has a height mark lamp for high level operation warning.

Anemometer

Anemometer at boom head can detect current wind speed and send wind signal to a monitor in operator's cabin to alert operator for safety.

NOTE

● Each mechanism is the part of internationalized supply, and selection of domestic and international famous manufacturers' product.

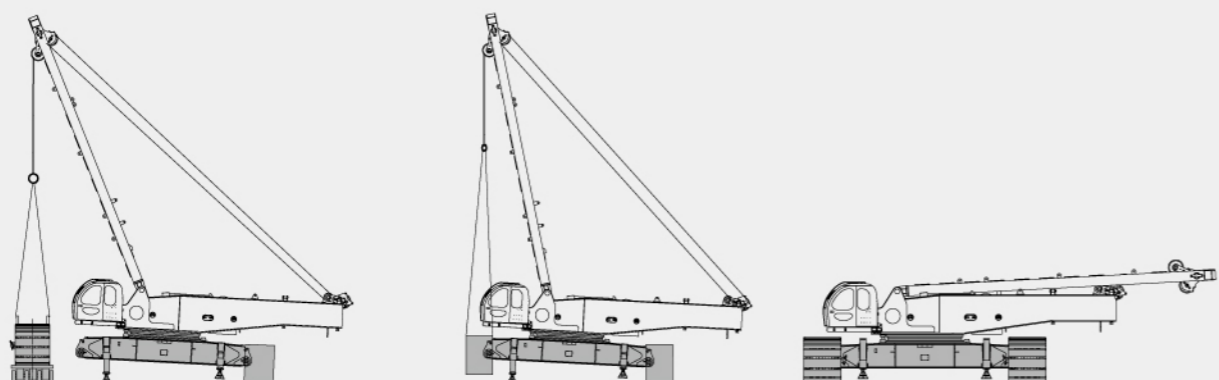
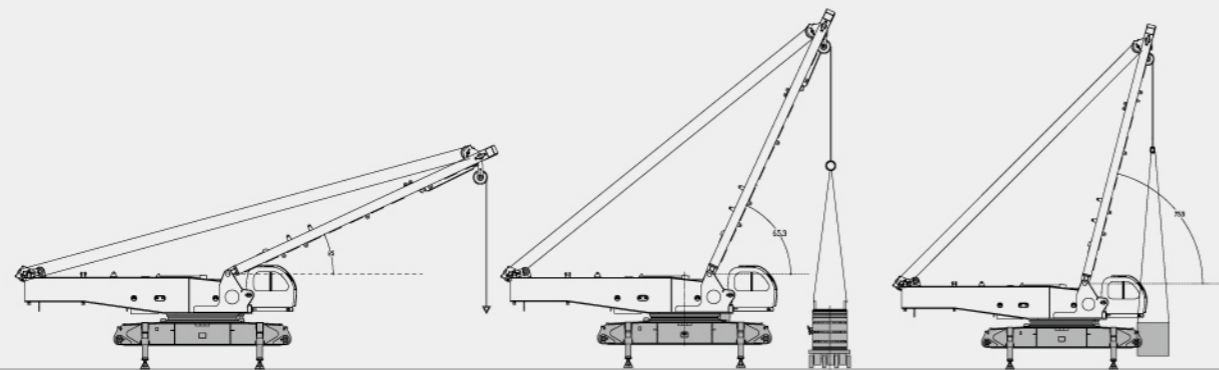

固定副臂安装示意图
Fixed Jib Installation Illustration

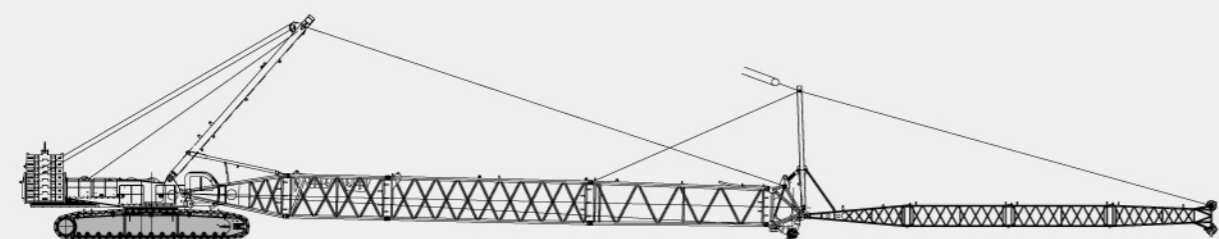
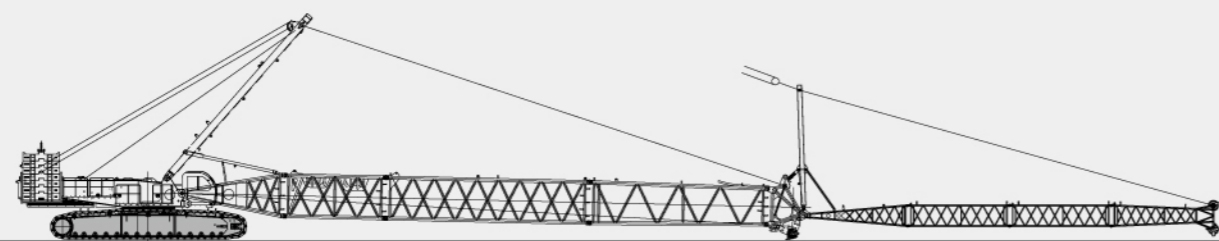

塔式副臂安装示意图
Tower Jib Installation Illustration



标准工况 Standard Mode

重型主臂
Heavy Boom

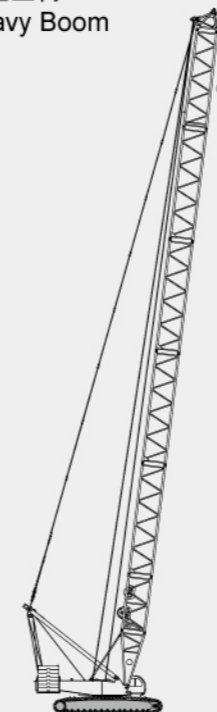

轻型主臂
Light Boom

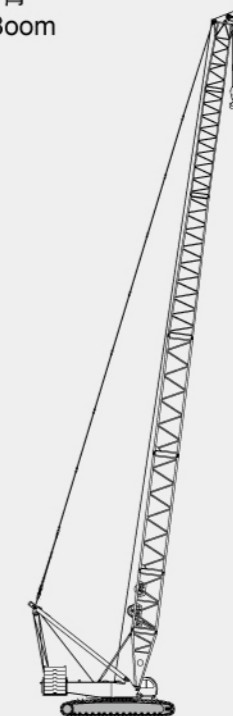

固定副臂
Fixed Jib

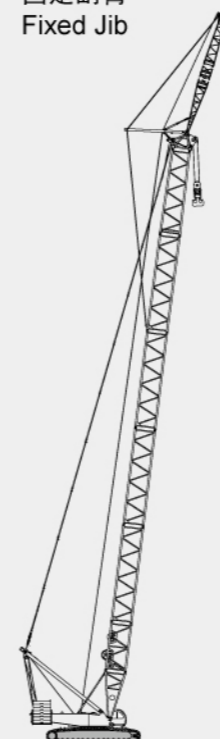

专用副臂
Special Jib

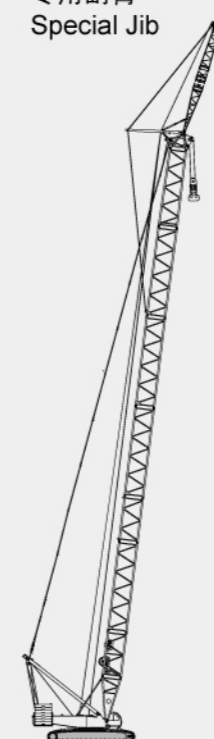

塔式副臂
Tower Jib

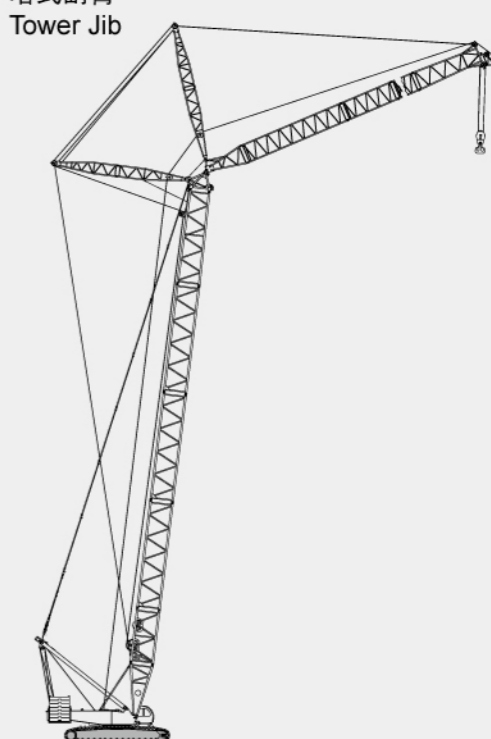

超起工况 SL Mode

重型主臂
Heavy Boom

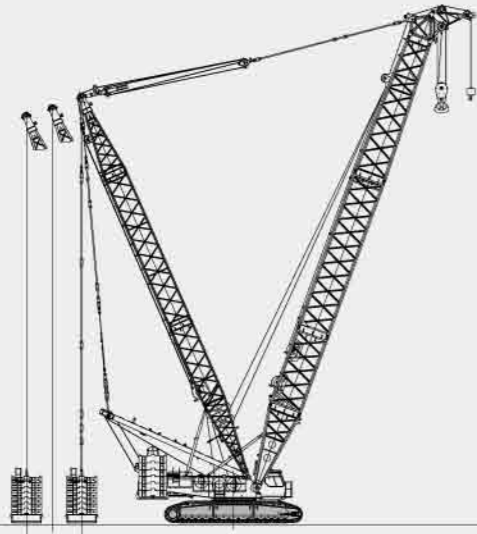

轻型主臂
Light Boom

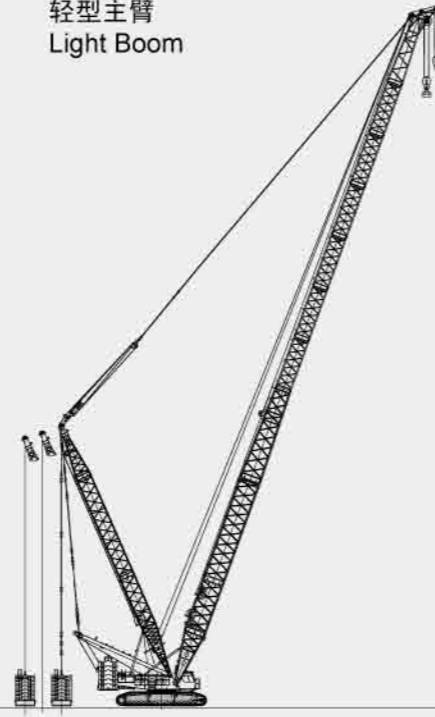

塔式副臂
Tower Jib

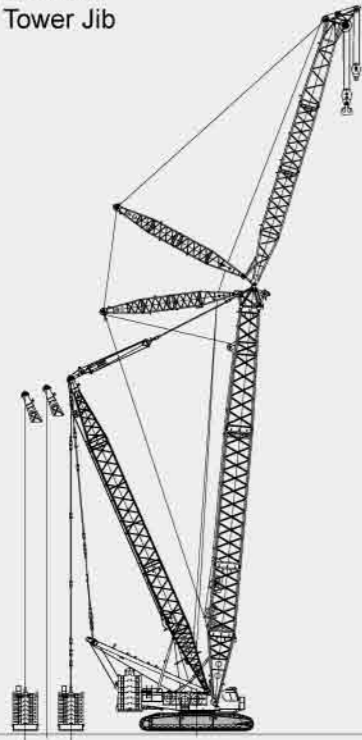

臂长 Boom length (m)	重型主臂中间节 Heavy boom insert		12m拉板节 12m Pedant section
	6m	12m	12m
24	-	-	-
30	1	-	-
36	-	-	1
42	1	-	1
48	2	-	1
54	1	1	1
60	2	1	1
66	1	2	1
72	2	2	1
78	1	3	1
84	2	3	1

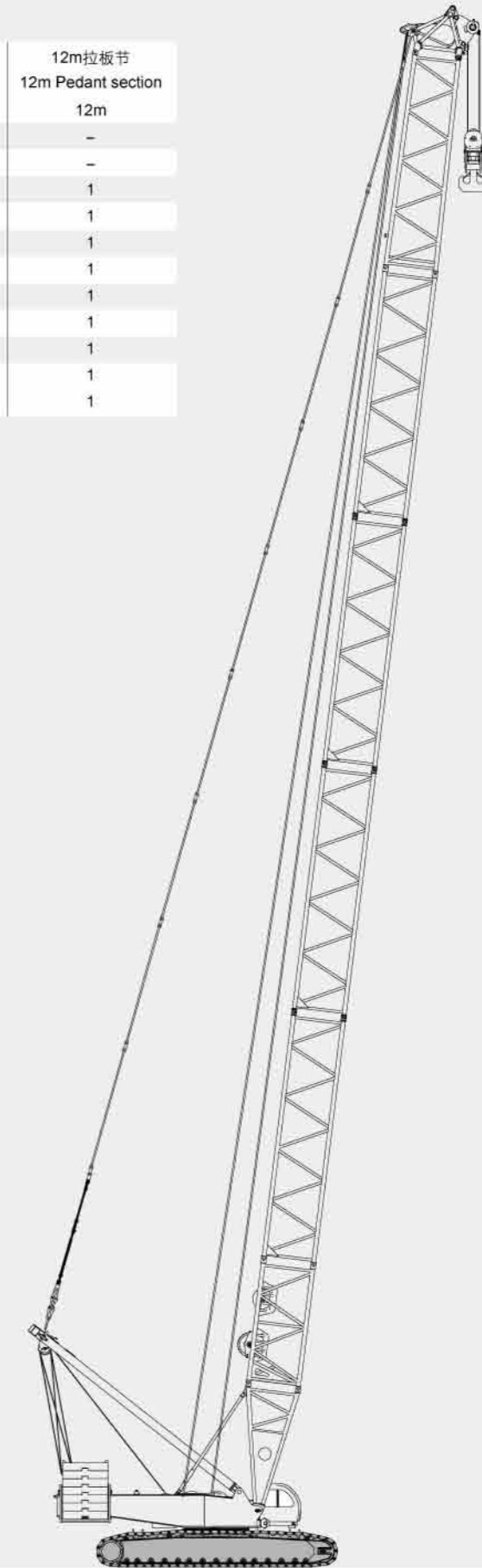

标准工况重型主臂作业范围 Standard Mode Heavy Boom Working Area

标准工况重型主臂载荷表 Standard Mode Heavy Boom Lifting Load Chart

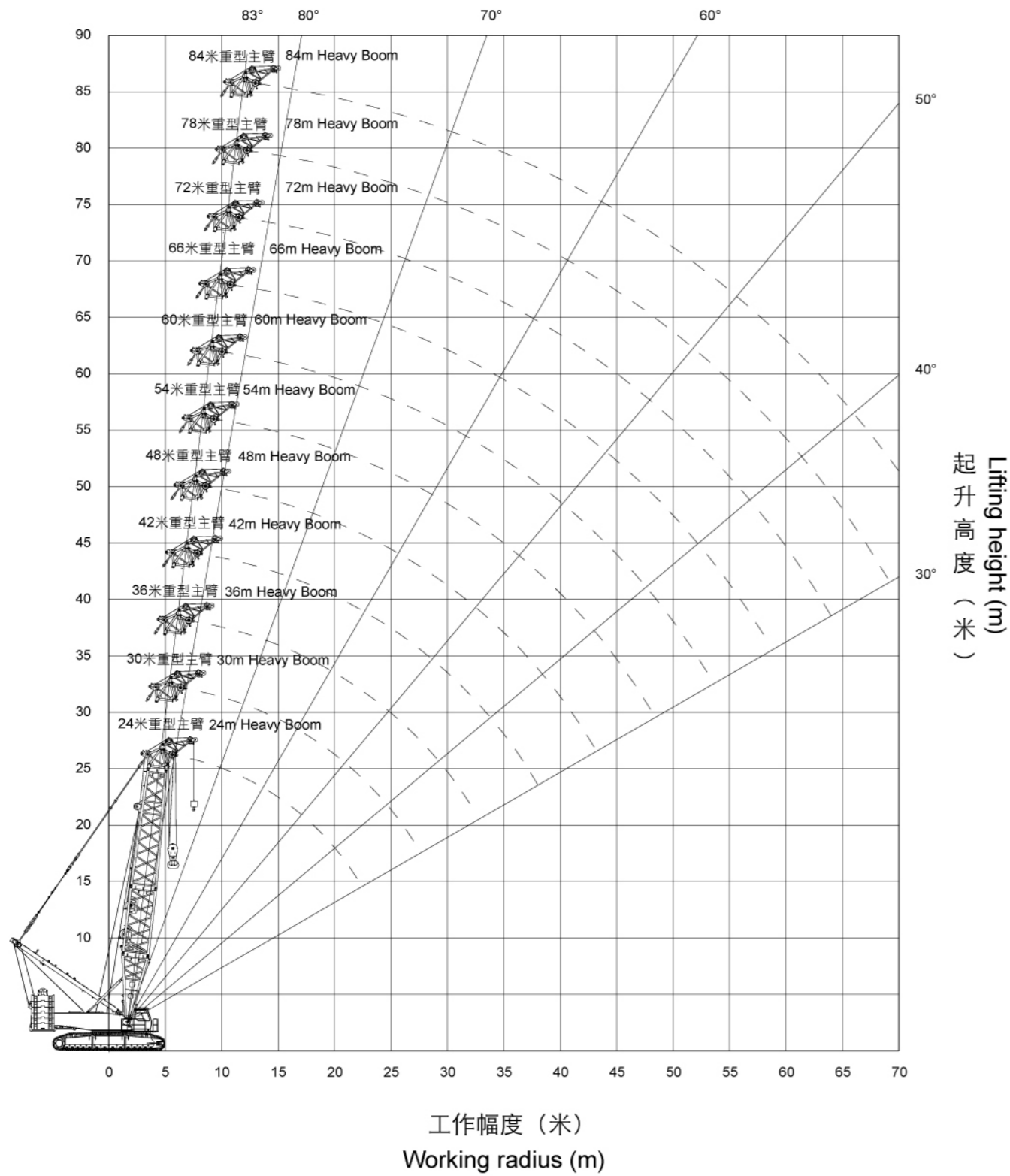

幅度Radius (m)	臂长 Boom length (m)											
	24	30	36	42	48	54	60	66	72	78	84	
6	380.0											
7	340.0	335.0										
8	290.0	288.0	285.0	283.0								
9	255.0	252.0	250.0	248.0	245.0							
10	225.0	223.0	220.0	218.0	215.0	205.0						
12	180.0	178.0	177.0	172.0	168.0	165.0	162.0	150.0	122.0			
14	144.0	144.0	143.0	139.0	136.0	135.0	133.0	130.0	118.0	96.0	75.0	
16	118.0	119.0	118.0	116.0	114.0	113.0	111.0	109.0	106.0	94.0	74.0	
18	100.0	100.0	100.0	99.0	98.0	97.0	94.0	93.0	91.0	86.0	72.0	
20	86.0	86.0	86.0	86.0	84.0	84.0	82.0	80.0	79.0	77.0	70.0	
22	75.0	75.0	75.0	75.0	74.0	73.5	72.0	71.0	70.0	68.0	68.0	
24		66.0	66.0	66.0	65.0	65.0	64.0	63.0	61.0	60.0	59.0	
26		59.0	59.0	59.0	58.0	58.0	57.0	56.0	55.0	54.0	52.0	
28			53.0	53.0	52.0	51.5	51.0	50.0	49.0	48.0	47.0	
30			48.0	47.0	47.0	46.0	46.0	45.0	44.0	43.5	42.0	
32			43.0	43.0	42.0	42.0	41.0	40.0	40.0	39.5	37.5	
34				39.0	39.0	38.0	37.0	37.0	36.0	35.5	34.0	
36				36.0	35.0	35.0	34.0	33.0	32.0	32.0	31.0	
38				33.0	32.0	32.0	31.0	30.0	29.5	29.0	28.0	
40					29.0	29.0	28.0	27.0	27.0	26.0	25.0	
42					27.0	26.5	26.0	25.0	24.5	24.0	23.0	
44						24.5	24.0	23.0	22.5	22.0	20.5	
46						22.5	22.0	21.0	20.5	19.5	19.0	
48						20.5	20.0	19.0	18.5	18.0	17.0	
50							18.0	18.0	17.0	16.0	15.0	
52							17.0	16.0	15.5	15.0	14.0	
54								15.0	14.0	13.0	12.0	
56								13.0	12.0	12.0	11.0	
58								12.0	11.0	11.0	10.0	
60									10.0	10.0	9.0	
62									9.0	9.0	7.0	
64									8.0	7.0	6.0	
66											5.0	

标准工况轻型主臂臂节组合/轻型主臂 Standard Mode Light Boom Combinations/Light Boom

主臂长度 Boom length (m)	重型主臂中间节 Heavy boom insert		塔式副臂中间节 Tower jib insert	
	6m	12m	6m	12m
42	-	1	-	-
48	-	1	1	-
54	-	2	-	-
60	-	2	1	-
66	-	2	-	1
72	1	3	-	-
78	1	3	1	-
84	1	3	-	1
90	1	3	1	1
96	1	3	2	1
102	1	3	1	2

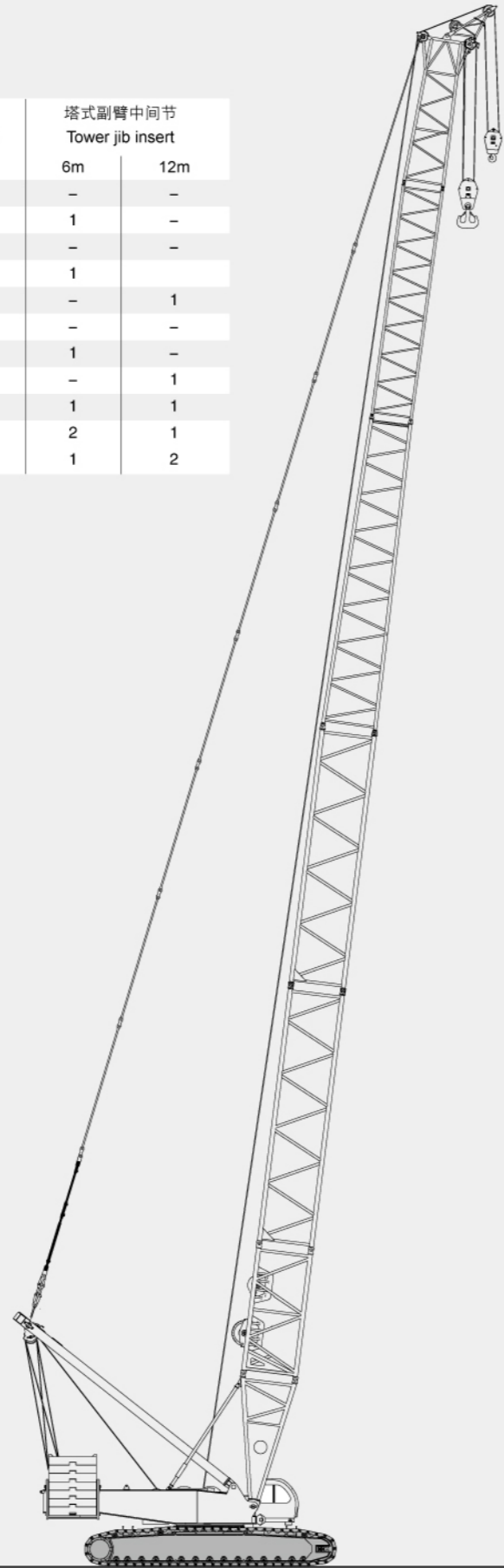

标准工况轻型主臂作业范围 Standard Mode Light Boom Working Area

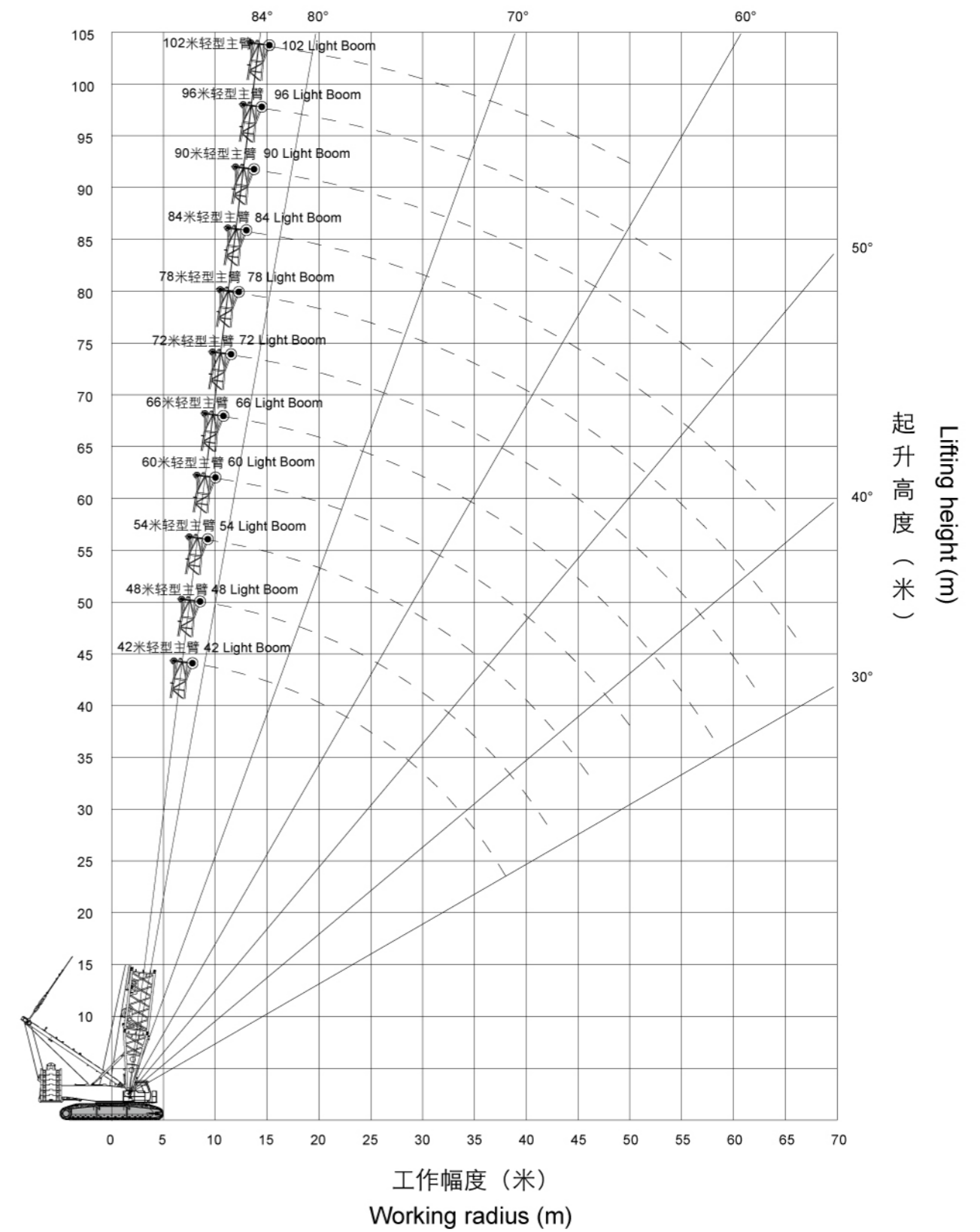

标准工况轻型主臂载荷表 Standard Mode Light Boom Lifting Load Chart

幅度Radius (m)	臂长 Boom length (m)										
	42	48	54	60	66	72	78	84	90	96	102
7	169.0										
8	171.0	166.0									
9	175.0	166.0	166.0	166.0							
10	180.0	167.0	167.0	167.0	132.0						
12	162.0	158.0	155.0	152.0	130.0	115.0	91.0	71.0			
14	126.0	130.0	128.0	125.0	116.0	110.0	90.0	70.0	59.0	42.0	34.0
16	106.0	104.0	103.0	101.0	99.0	101.0	88.0	68.0	53.0	42.0	33.0
18	91.0	90.0	88.0	87.0	88.0	87.0	84.0	67.0	51.0	41.0	32.0
20	80.0	79.0	77.0	76.0	75.0	72.0	74.0	64.0	50.0	40.0	27.0
22	70.0	70.0	69.0	68.0	65.0	64.0	63.0	59.0	49.0	40.0	27.0
24	62.0	62.0	61.0	61.0	58.0	57.0	56.0	50.0	46.0	38.0	26.0
26	56.0	56.0	55.0	55.0	49.0	51.0	49.0	45.0	41.0	37.0	25.0
28	50.0	50.0	49.0	49.0	45.0	46.0	44.0	40.0	36.0	33.0	24.0
30	45.0	46.0	45.0	44.0	41.0	42.0	39.0	37.0	32.0	25.0	22.0
32	42.0	42.0	41.0	40.0	37.0	38.0	36.0	32.0	25.0	22.0	19.0
34	38.0	38.0	37.0	37.0	33.0	35.0	32.0	25.0	22.0	19.0	16.0
36	35.0	35.0	34.0	34.0	30.0	32.0	27.0	23.0	19.0	17.0	14.0
38	32.0	32.0	31.0	31.0	26.0	26.0	24.0	20.0	17.0	14.0	12.0
40		30.0	25.0	25.0	23.0	24.0	22.0	18.0	15.0	12.0	10.0
42		28.0	23.0	24.0	21.0	22.0	19.0	16.0	13.0	10.0	8.0
44			21.0	21.0	19.0	20.0	17.0	14.0	11.0	9.0	6.0
46			20.0	20.0	17.0	18.0	16.0	12.0	9.0	7.0	5.0
48				18.0	15.0	17.0	14.0	10.0	8.0	6.0	3.0
50				16.0	14.0	15.0	12.0	9.0	6.0	4.0	2.0
52					12.0	14.0	10.0	8.0	5.0	3.0	
54					11.0	13.0	9.0	7.0	4.0	2.0	
56					10.0	12.0	8.0	6.0	3.0		
58					8.0	11.0	7.0	5.0	2.0		
60						10.0	6.0	4.0			
62						9.0	5.0	3.0			
64							4.0	2.0			
66							3.0				

标准工况固定副臂臂节组合/固定副臂 Standard Mode Fixed Jib Combinations/Fixed Jib

主臂长度 Boom length (m)	重型主臂中间节 Heavy boom insert		12m拉板节 12m Pedant section
	6m	12m	12m
36	-	-	1
42	1	-	1
48	2	-	1
54	1	1	1
60	2	1	1
66	1	2	1
72	2	2	1

副臂长度 Jib length (m)	中间节 Jib insert	主臂长度 Boom length (m)	主副臂夹角 Angle between boom and jib (°)
12	-	36~72	10°, 30°
18	1	36~72	10°, 30°
24	2	36~72	10°, 30°
30	3	36~72	10°, 30°
36	4	36~72	10°, 30°

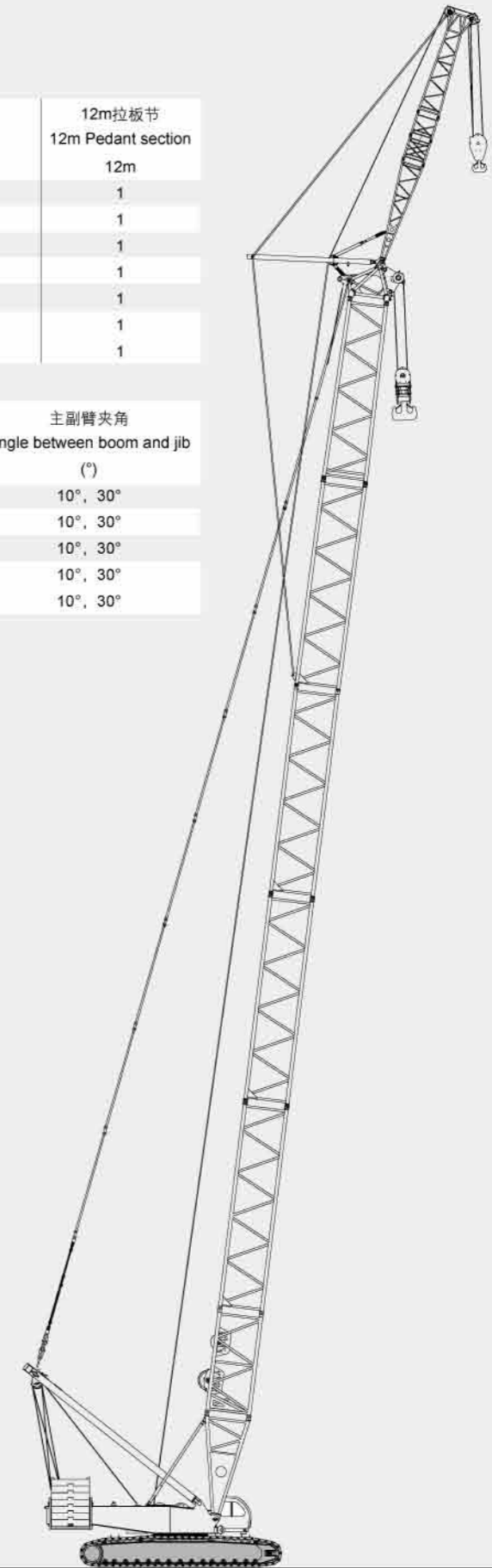

标准工况固定副臂作业范围 Standard Mode Fixed Jib Working Area

标准工况重型主臂+固定副臂载荷表 Standard Mode Heavy Boom + Fixed Jib Lifting Load Chart

固定副臂10°时 Fixed jib angle at 10°

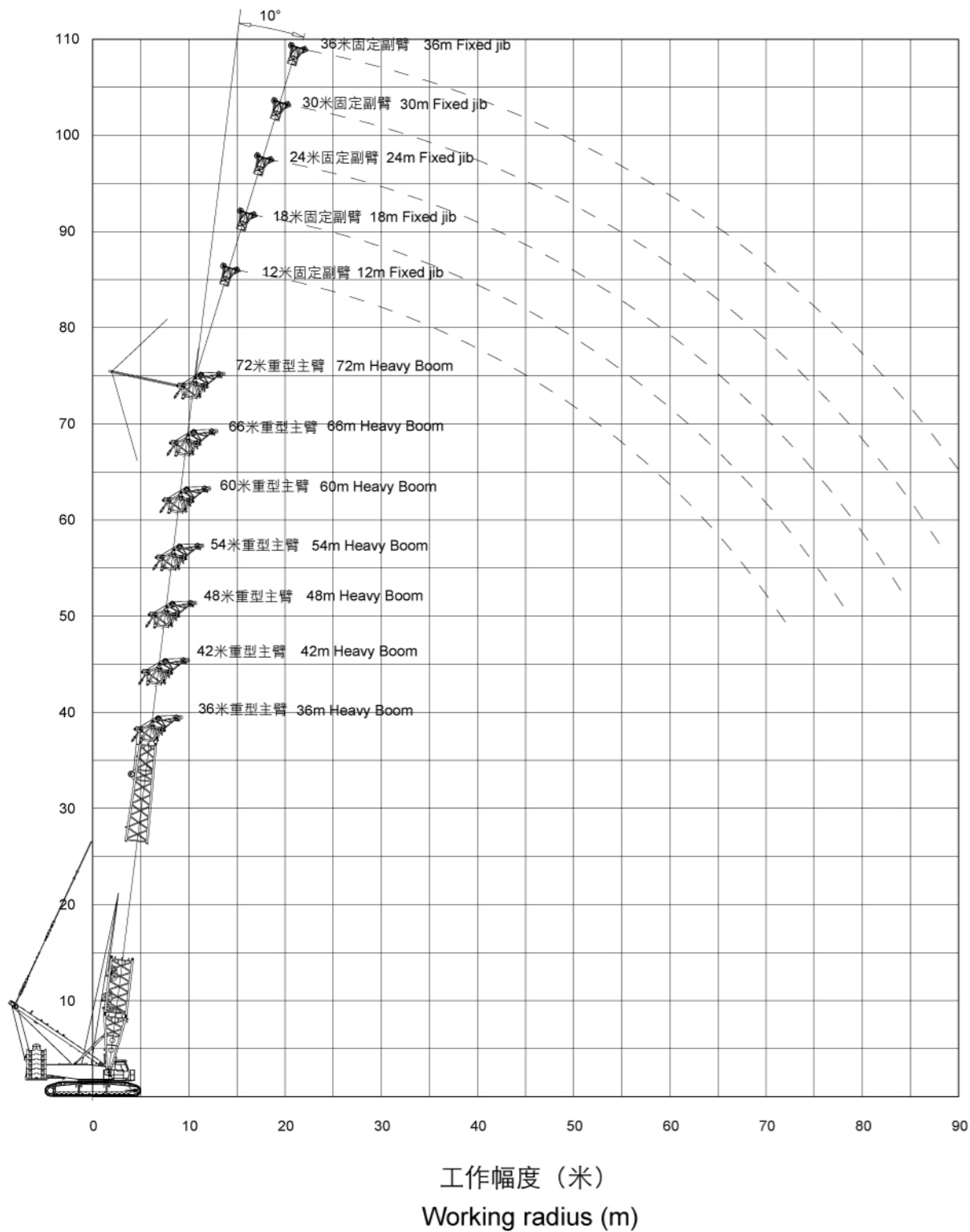

主臂长度 Boom length (m)	主臂36米 Boom length 36m						主臂42米 Boom length 42m					
	12		24		36		12		24		36	
	副臂长度 Jib length (m)											
幅度 Radius (m)	安装角 Offset angle (°)											
	10	30	10	30	10	30	10	30	10	30	10	30
12	80.0						80.0					
14	79.0						80.0					
16	77.0	39.0	62.0				79.0	39.0	64.0			
18	75.0	37.0	60.0		36.0		78.0	38.0	61.0			
20	73.0	35.0	57.0		35.0		76.0	36.0	59.0		35.0	
22	71.0	33.0	53.0	17.0	34.0		73.0	35.0	54.0		35.0	
24	68.0	32.0	51.0	17.0	34.0		67.0	33.0	53.0	17.0	34.0	
26	61.0	31.0	48.0	16.0	33.0		60.0	32.0	50.0	16.0	33.0	
28	54.0	24.0	46.0	15.0	32.0		54.0	31.0	48.0	16.0	33.0	
30	49.0	23.0	43.0	15.0	31.0	10.0	49.0	30.0	46.0	15.0	32.0	10.0
32	45.0	23.0	41.0	14.0	31.0	9.0	44.0	24.0	44.0	15.0	31.0	10.0
34	41.0	22.0	39.0	14.0	29.0	9.0	40.0	23.0	42.0	14.0	31.0	9.0
36	37.0	21.0	38.0	13.0	28.0	9.0	37.0	22.0	39.0	14.0	29.0	9.0
38	34.0	21.0	36.0	13.0	24.0	8.0	33.0	22.0	36.0	13.0	28.0	8.0
40	31.0	20.0	34.0	12.0	23.0	8.0	31.0	21.0	33.0	13.0	24.0	8.0
42	29.0	20.0	31.0	12.0	22.0	8.0	28.0	21.0	30.0	12.0	23.0	8.0
44		20.0	29.0	12.0	21.0	7.0	26.0	20.0	28.0	12.0	22.0	8.0
46			27.0	11.0	20.0	7.0	24.0	20.0	26.0	12.0	21.0	7.0
48			25.0	11.0	19.0	7.0	22.0	20.0	24.0	11.0	20.0	7.0
50			23.0	11.0	18.0	7.0		19.0	22.0	11.0	19.0	7.0
52			22.0	11.0	17.0	6.0			21.0	11.0	19.0	7.0
54			20.0	10.0	17.0	6.0			19.0	11.0	18.0	7.0
56				10.0	16.0	6.0			18.0	11.0	17.0	6.0
58					16.0	6.0			17.0	11.0	17.0	6.0
60					15.0	6.0			16.0	10.0	16.0	6.0
62					14.0	6.0				10.0	16.0	6.0
64					14.0	5.0					15.0	6.0
66					14.0	5.0					14.0	6.0
68						5.0					13.0	5.0
70											12.0	5.0
72												5.0

标准工况重型主臂+固定副臂载荷表 Standard Mode Heavy Boom + Fixed Jib Lifting Load Chart

主臂长度 Boom length (m)	主臂48米 Boom length 48m						主臂54米 Boom length 54m					
	12		24		36		12		24		36	
	副臂长度 Jib length (m)											
幅度 Radius (m)	安装角 Offset angle (°)											
	10	30	10	30	10	30	10	30	10	30	10	30
14	80.0						80.0					
16	79.0	40.0	65.0				80.0					
18	78.0	39.0	62.0				78.0	39.0	63.0			
20	76.0	37.0	60.0			36.0	76.0	38.0	61.0		36.0	
22	74.0	36.0	58.0			35.0	73.0	37.0	59.0		35.0	
24	66.0	34.0	54.0	17.0	34.0		65.0	35.0	57.0	18.0	35.0	
26	59.0	33.0	52.0	17.0	34.0		58.0	34.0	53.0	17.0	34.0	
28	53.0	32.0	50.0	16.0	33.0		52.0	33.0	52.0	16.0	33.0	
30	48.0	31.0	48.0	15.0	32.0		47.0	32.0	49.0	16.0	33.0	
32	43.0	30.0	45.0	15.0	32.0	10.0	42.0	31.0	44.0	15.0	32.0	10.0
34	39.0	24.0	41.0	15.0	31.0	9.0	39.0	30.0	41.0	15.0	32.0	10.0
36	36.0	23.0	38.0	14.0	31.0	9.0	35.0	24.0	37.0	15.0	31.0	9.0
38	33.0	23.0	35.0	14.0	30.0	9.0	32.0	23.0	34.0	14.0	30.0	9.0
40	30.0	22.0	32.0	13.0	28.0	8.0	29.0	23.0	31.0	14.0	30.0	9.0
42	27.0	22.0	29.0	13.0	24.0	8.0	27.0	22.0	29.0	13.0	28.0	8.0
44	25.0	21.0	27.0	13.0	23.0	8.0	24.0	22.0	26.0	13.0	24.0	8.0
46	23.0	21.0	25.0	12.0	22.0	8.0	22.0	21.0	24.0	13.0	23.0	8.0
48	21.0	20.0	23.0	12.0	21.0	7.0	21.0	19.0	22.0	12.0	23.0	8.0
50	20.0	18.0	22.0	12.0	21.0	7.0	19.0	18.0	21.0	12.0	22.0	7.0
52	18.0	17.0	20.0	11.0	20.0	7.0	17.0	16.0	19.0	12.0	20.0	7.0
54	17.0	15.0	19.0	11.0	19.0	7.0	16.0	15.0	18.0	12.0	19.0	7.0
56			17.0	11.0	19.0	7.0	15.0	13.0	17.0	11.0	18.0	7.0
58			16.0	11.0	17.0	6.0	13.0	12.0	15.0	11.0	16.0	7.0
60			15.0	11.0	16.0	6.0		11.0	14.0	11.0	15.0	6.0
62			14.0	11.0	15.0	6.0			13.0	11.0	14.0	6.0
64			13.0	10.0	14.0	6.0			12.0	11.0	13.0	6.0
66				10.0	13.0	6.0			11.0	10.0	12.0	6.0
68					12.0	6.0			10.0	9.0	11.0	6.0
70					11.0	6.0			9.0	8.0	10.0	6.0
72					10.0	5.0				7.0	10.0	6.0
74					10.0	5.0					9.0	6.0
76					9.0	5.0					8.0	5.0
78						5.0					7.0	5.0
80											7.0	5.0
82												5.0

标准工况重型主臂+固定副臂载荷表 Standard Mode Heavy Boom + Fixed Jib Lifting Load Chart

主臂长度 Boom length (m)	主臂60米 Boom length 60m						主臂66米 Boom length 66m					
	12		24		36		12		24		36	
	副臂长度 Jib length (m)											
幅度 Radius (m)	安装角 Offset angle (°)											
	10	30	10	30	10	30	10	30	10	30	10	30
14	80.0											
16	80.0								80.0			
18	80.0	40.0	64.0						80.0	40.0	65.0	
20	76.0	39.0	62.0						79.0	39.0	63.0	
22	71.0	37.0	60.0			36.0			69.0	38.0	61.0	
24	63.0	36.0	58.0			35.0			62.0	37.0	59.0	35.0
26	56.0	35.0	55.0	17.0	35.0				55.0	36.0	56.0	17.0
28	51.0	34.0	52.0	17.0	34.0				49.0	35.0	51.0	17.0
30	46.0	33.0	47.0	16.0	33.0				45.0	34.0	46.0	16.0
32	42.0	32.0	43.0	16.0	33.0	10.0			41.0	33.0	42.0	16.0
34	38.0	31.0	39.0	15.0	32.0	10.0			37.0	32.0	38.0	15.0
36	34.0	30.0	36.0	15.0	32.0	9.0			33.0	31.0	35.0	15.0
38	31.0	30.0	33.0	14.0	31.0	9.0			30.0	29.0	32.0	15.0
40	28.0	24.0	30.0	14.0	30.0	9.0			28.0	27.0	30.0	14.0
42	26.0	23.0	28.0	14.0	29.0	9.0			25.0	24.0	27.0	14.0
44	24.0	22.0	26.0	13.0	27.0	8.0			23.0	22.0	25.0	14.0
46	22.0	20.0	24.0	13.0	24.0	8.0			21.0	20.0	23.0	13.0
48	20.0	19.0	22.0	13.0	23.0	8.0			19.0	18.0	21.0	13.0
50	18.0	17.0	20.0	13.0	21.0	8.0			17.0	16.0	19.0	13.0
52	17.0	15.0	18.0	12.0	20.0	7.0			16.0	15.0	18.0	13.0
54	15.0	14.0	17.0	12.0	18.0	7.0			14.0	13.0	16.0	12.0
56	14.0	13.0	16.0	12.0	17.0	7.0			13.0	12.0	15.0	12.0
58	12.0	11.0	14.0	12.0	16.0	7.0			12.0	11.0	14.0	12.0
60	11.0	10.0	13.0	11.0	14.0	7.0			11.0	10.0	12.0	12.0
62	10.0	9.0	12.0	11.0	13.0	7.0			9.0	9.0	11.0	11.0
64	9.0	8.0	11.0	11.0	12.0	6.0			9.0	7.0	10.0	10.0
66			10.0	10.0	11.0	6.0			8.0	7.0	9.0	9.0
68			9.0	9.0	10.0	6.0			7.0	6.0	8.0	8.0
70			8.0	8.0	9.0	6.0				5.0	8.0	7.0
72			7.0	7.0	9.0	6.0					7.0	6.0
74			7.0	6.0	8.0	6.0					6.0	5.0
76			5.0	7.0	6.0						5.0	5.0
78				7.0	6.0						5.0	4.0
80					6.0	5.0					4.0	3.0
82					5.0	5.0						2.0
84					5.0	4.0						4.0
86					4.0	4.0						3.0
88						3.0						3.0
90												2.0
92												2.0

标准工况重型主臂+固定副臂载荷表 Standard Mode Heavy Boom + Fixed Jib Lifting Load Chart

主臂长度 Boom length (m)	主臂72米 Boom length 72m					
	12		24		36	
	安装角 Offset angle (°)					
幅度 Radius (m)	10	30	10	30	10	30
16	79.0					
18	78.0					
20	77.0	40.0	61.0			
22	68.0	39.0	61.0			
24	60.0	38.0	60.0		36.0	
26	54.0	36.0	55.0	18.0	35.0	
28	48.0	35.0	49.0	17.0	35.0	
30	43.0	35.0	45.0	17.0	34.0	
32	39.0	34.0	41.0	16.0	33.0	
34	36.0	33.0	37.0	16.0	33.0	10.0
36	32.0	32.0	34.0	15.0	33.0	10.0
38	29.0	29.0	31.0	15.0	32.0	9.0
40	27.0	26.0	28.0	15.0	29.0	9.0
42	24.0	23.0	26.0	14.0	27.0	9.0
44	22.0	21.0	24.0	14.0	25.0	9.0
46	20.0	19.0	22.0	14.0	23.0	8.0
48	18.0	17.0	20.0	13.0	21.0	8.0
50	16.0	16.0	18.0	13.0	20.0	8.0
52	15.0	14.0	17.0	13.0	18.0	8.0
54	13.0	13.0	15.0	13.0	17.0	8.0
56	12.0	11.0	14.0	12.0	15.0	7.0
58	11.0	10.0	13.0	12.0	14.0	7.0
60	10.0	9.0	12.0	12.0	13.0	7.0
62	9.0	8.0	10.0	10.0	12.0	7.0
64	8.0	7.0	9.0	9.0	11.0	7.0
66	7.0	6.0	8.0	8.0	10.0	7.0
68	6.0	5.0	7.0	7.0	9.0	7.0
70	5.0	4.0	7.0	6.0	8.0	6.0
72	4.0	3.0	6.0	6.0	7.0	6.0
74		2.0	5.0	5.0	6.0	6.0
76			4.0	4.0	6.0	6.0
78			4.0	3.0	5.0	5.0
80			3.0	2.0	4.0	4.0
82			2.0	2.0	4.0	4.0
84			2.0		3.0	3.0
86					2.0	2.0
88					2.0	2.0
90					2.0	

标准工况专用副臂臂节组合/专用副臂 Standard Mode special Jib Combinations/special Jib

主臂长度 Boom length (m)	重型主臂中间节 Heavy boom insert		12m拉板节 12m Pedant section
	6m	12m	12m
72	2	2	1
78	1	3	1

副臂长度 Jib length (m)	主臂长度 (m) Boom length (m)	主副臂夹角 Angle between boom and jib (°)
18	72~78	10°

标准工况专用副臂性能表

主臂 Boom (m)	72		78	
	副臂 Jib(m)			
	12	18	12	18
幅度 Radius(m)	安装角 Offset angle (°)			
	10°			
16	79		75	
18	78	73	74	70
20	77	71	73	69
22	68	68	66	67
24	60	61	59	59
26	54	54	52	53
28	48	49	47	47
30	43	44	42	43
32	39	40	38	39
34	36	36	34	35
36	32	33	31	32
38	29	30	29	29
40	27	28	26	27
42	24	25	24	24
44	22	23	21	22
46	20	21	19	20
48	18	19	17	18
50	16	17	16	17
52	15	16	14	15
54	13	14	13	14
56	12	13	11	12
58	11	12	10	11
60	10	11	9	10
62	9	10	8	9
64	8	9	7	8
66	7	8	6	7
68		7	5	6
70			4	5

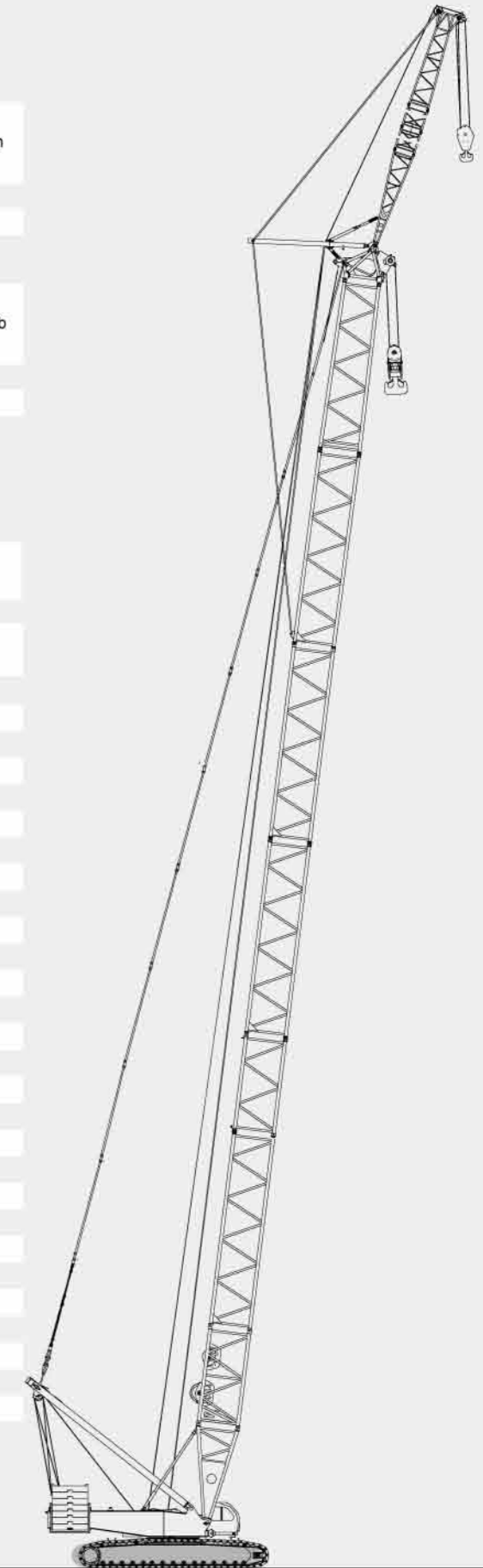

标准工况专用副臂作业范围 Standard Mode special Jib Working Area

标准工况塔式副臂臂节组合/塔式副臂 Standard Mode Tower Jib Combinations/Tower Jib

专用副臂10°时 special Jib at 10°

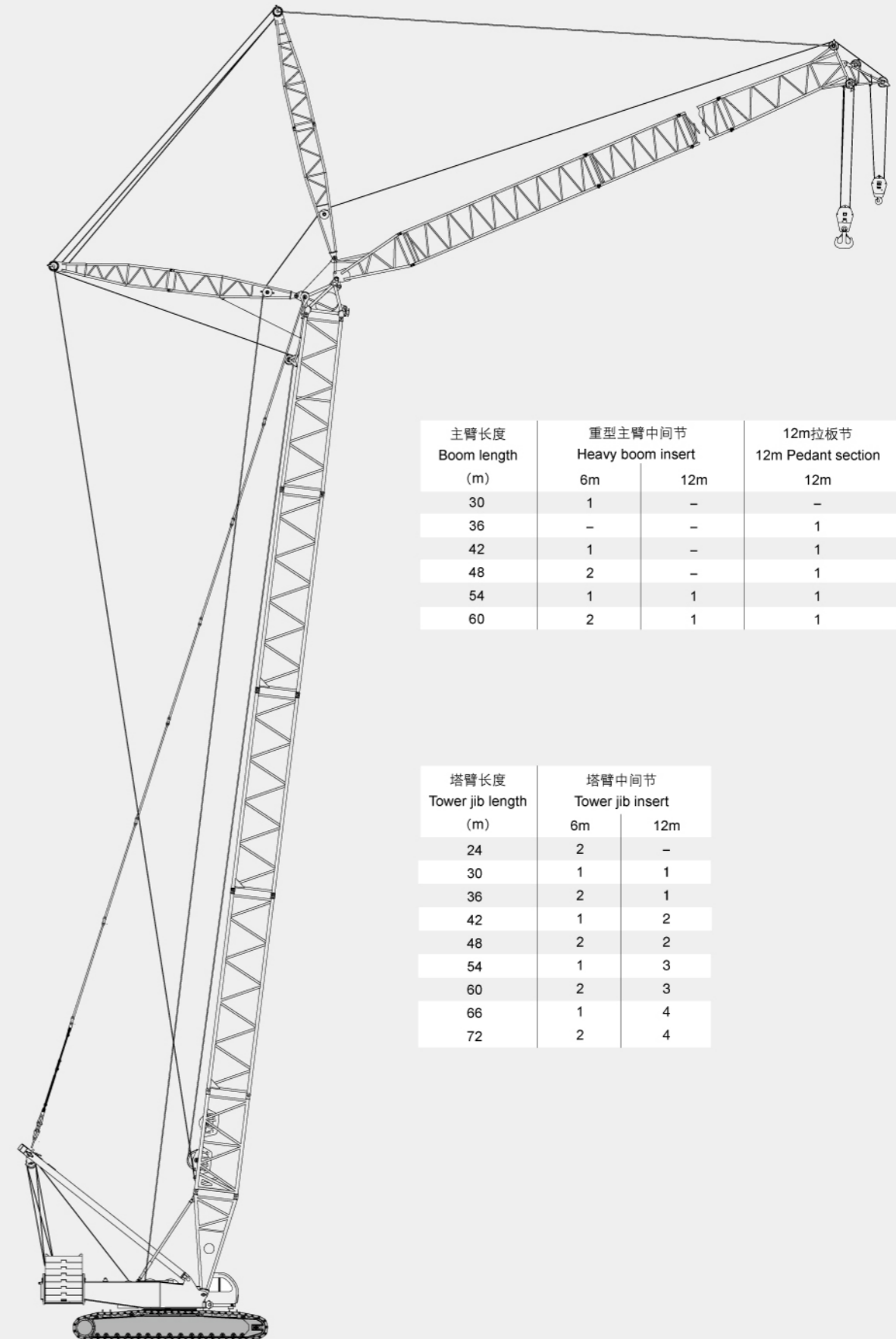
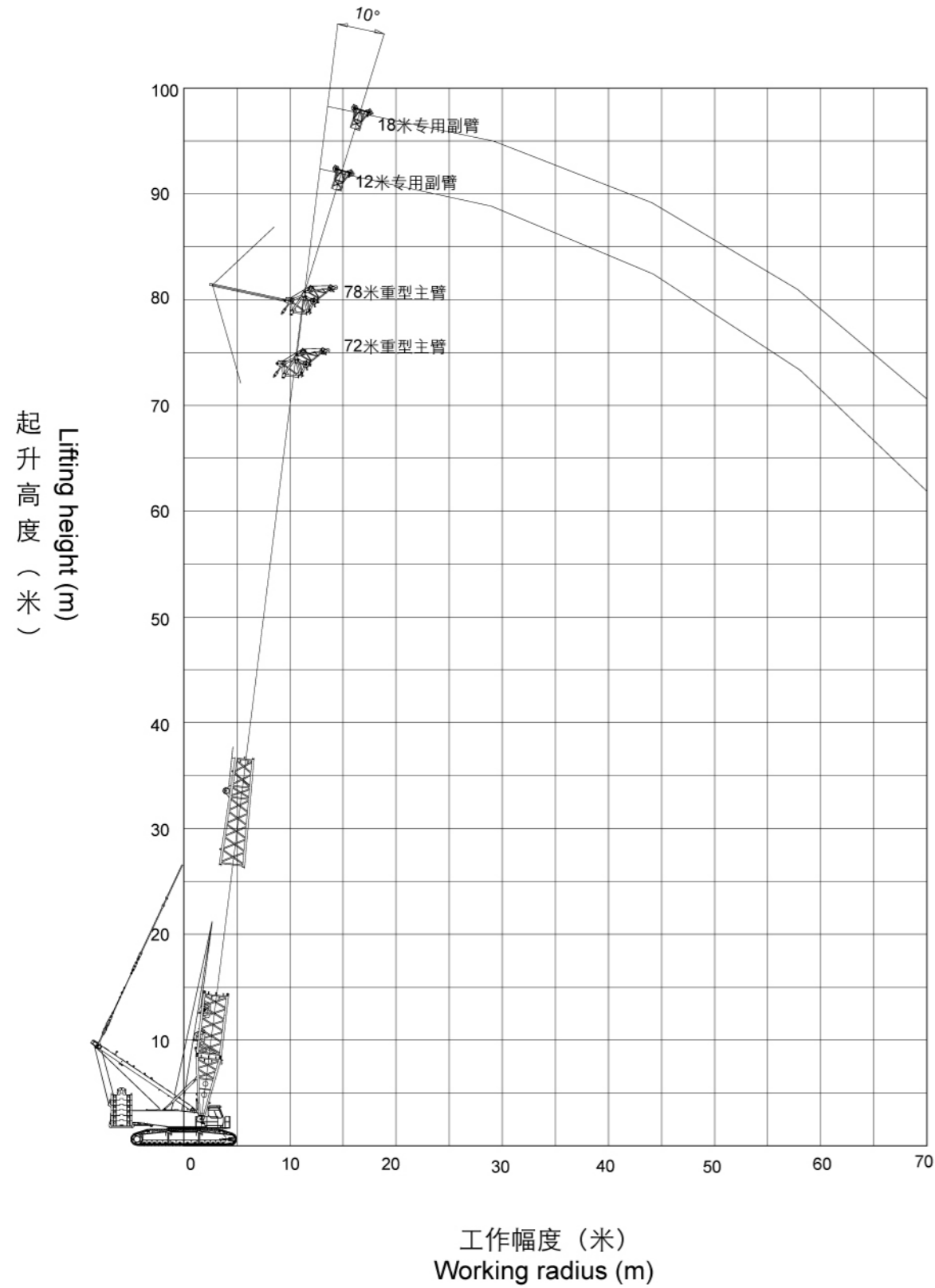

标准工况塔式副臂作业范围 Standard Mode Tower Jib Working Area

标准工况塔式副臂载荷表 Standard Mode Tower Jib Lifting Load Chart

主臂仰角85°时 Boom angle at 85°

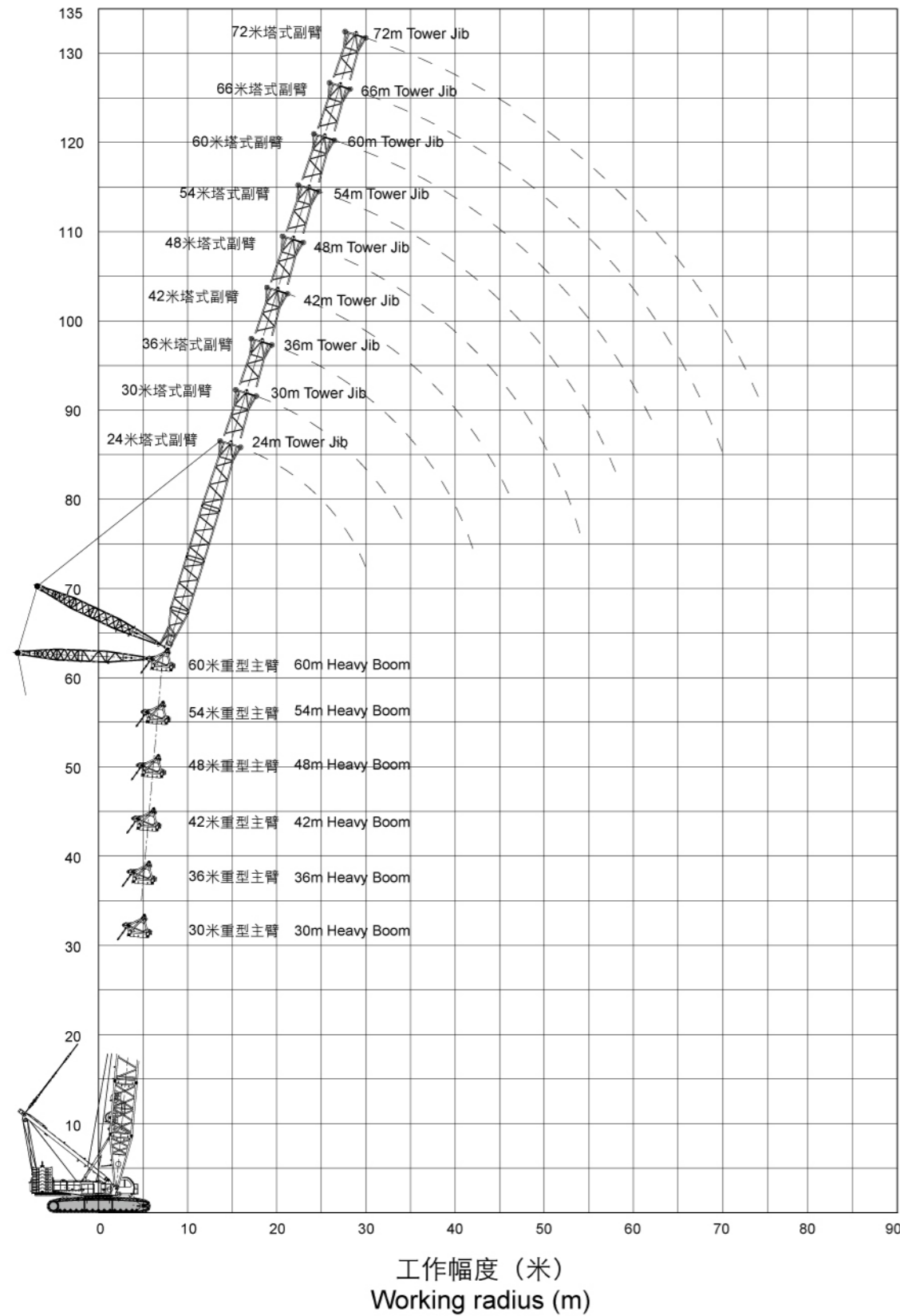

起升高度 (米)
Lifting height (m)

主臂长度 Boom length (m)	主臂30米 Boom length 30m									
	塔臂长度 Tower Jib length (m)	24	30	36	42	48	54	60	66	72
幅度 Radius (m)	主臂角度 Boom angle (°)									
	85									
14	142.0									
16	117.0	117.0								
18	100.0	99.0	99.0	98.0						
20	87.0	86.0	85.0	85.0	84.0					
22	76.0	76.0	75.0	74.0	74.0	72.0				
24	68.0	67.0	67.0	66.0	66.0	65.0	52.0			
26	61.0	61.0	60.0	59.0	59.0	58.0	51.0	40.0		
28	55.0	55.0	54.0	54.0	53.0	53.0	49.0	39.0	30.0	
30		50.0	50.0	49.0	48.0	48.0	47.0	38.0	27.0	
32		46.0	46.0	45.0	44.0	44.0	45.0	38.0	25.0	
34			42.0	41.0	41.0	40.0	40.0	37.0	25.0	
36			38.0	38.0	38.0	37.0	36.0	35.0	24.0	
38			36.0	35.0	35.0	34.0	34.0	33.0	23.0	
40				32.0	32.0	31.0	31.0	31.0	23.0	
42				31.0	30.0	30.0	29.0	29.0	21.0	
44					28.0	28.0	27.0	27.0	21.0	
46					26.0	26.0	25.0	25.0	20.0	
48					24.0	24.0	23.0	23.0	19.0	
50						23.0	22.0	22.0	18.0	
52						21.0	20.0	21.0	17.0	
54						20.0	19.0	19.0	17.0	
56							18.0	18.0	16.0	
58							17.0	17.0	15.0	
60							16.0	16.0	14.0	
62								15.0	13.0	
64									14.0	12.0
66										11.0
68										11.0
70										10.0

标准工况塔式副臂载荷表 Standard Mode Tower Jib Lifting Load Chart

主臂长度 Boom length (m)		主臂30米 Boom length 30m								
塔臂长度 Tower Jib length (m)		24	30	36	42	48	54	60	66	72
幅度 Radius (m)	主臂角度 Boom angle (°)									
	75									
24	62.0									
26	56.0	55.0								
28	51.0	50.0	49.0							
30	46.0	46.0	45.0							
32		42.0	41.0							
34		39.0	38.0	37.0						
36		36.0	35.0	34.0	33.0					
38			32.0	31.0	31.0	30.0				
40			29.0	28.0	28.0	28.0				
42			28.0	27.0	27.0	26.0	25.0			
44				25.0	25.0	24.0	23.0	23.0		
46				24.0	23.0	23.0	22.0	21.0	20.0	
48				22.0	21.0	21.0	20.0	19.0	19.0	
50					20.0	20.0	19.0	18.0	17.0	
52					18.0	18.0	18.0	17.0	16.0	
54						17.0	16.0	16.0	15.0	
56						16.0	15.0	15.0	14.0	
58						15.0	14.0	14.0	13.0	
60							13.0	13.0	12.0	
62							12.0	12.0	11.0	
64							11.0	11.0	10.0	
66								10.0	9.0	
68								9.0	8.0	
70									7.0	
72									7.0	
74									6.0	

标准工况塔式副臂载荷表 Standard Mode Tower Jib Lifting Load Chart

主臂长度 Boom length (m)		主臂30米 Boom length 30m								
塔臂长度 Tower Jib length (m)		24	30	36	42	48	54	60	66	72
幅度 Radius (m)	主臂角度 Boom angle (°)									
	65									
34	36.0									
36	33.0									
38		30.0								
40		28.0	27.0							
42		26.0	26.0	25.0						
44			24.0	23.0						
46			22.0	21.0	20.0					
48			20.0	19.0	18.0					
50				18.0	17.0	17.0				
52					17.0	16.0	16.0			
54						15.0	15.0	14.0		
56						14.0	14.0	13.0	12.0	
58						14.0	13.0	12.0	11.0	
60							12.0	11.0	10.0	9.0
62								11.0	10.0	9.0
64								10.0	9.0	8.0
66									8.0	7.0
68									8.0	7.0
70									8.0	6.0
72										6.0
74										6.0
76										5.0
78										5.0
80										5.0
										4.0
										4.0
										3.0
										3.0

标准工况塔式副臂载荷表 Standard Mode Tower Jib Lifting Load Chart

主臂长度 Boom length (m)		主臂60米 Boom length 60m								
塔臂长度 Tower Jib length (m)		24	30	36	42	48	54	60	66	72
幅度 Radius (m)	主臂角度 Boom angle (°)									
	85									
16	90.0									
18	89.0	79.0								
20	81.0	75.0	66.0							
22	74.0	70.0	64.0	57.0						
24	66.0	65.0	61.0	54.0	48.0	42.0				
26	59.0	58.0	57.0	52.0	46.0	41.0	35.0			
28	53.0	53.0	52.0	49.0	45.0	40.0	34.0	30.0		
30		48.0	47.0	47.0	43.0	38.0	33.0	29.0	24.0	
32		44.0	44.0	43.0	39.0	34.0	32.0	28.0	23.0	
34		41.0	40.0	39.0	37.0	33.0	31.0	28.0	22.0	
36			37.0	36.0	36.0	32.0	29.0	27.0	21.0	
38			34.0	33.0	33.0	30.0	28.0	26.0	20.0	
40			30.0	31.0	31.0	29.0	27.0	25.0	20.0	
42				29.0	29.0	28.0	26.0	24.0	19.0	
44				27.0	27.0	26.0	25.0	22.0	18.0	
46				26.0	25.0	24.0	24.0	21.0	18.0	
48					23.0	23.0	22.0	20.0	17.0	
50					22.0	21.0	21.0	19.0	16.0	
52					20.0	20.0	20.0	18.0	16.0	
54						19.0	18.0	17.0	15.0	
56						17.0	17.0	16.0	15.0	
58							16.0	15.0	14.0	
60							14.0	14.0	13.0	
62							14.0	13.0	13.0	
64								12.0	12.0	
66								11.0	11.0	
68								10.0	10.0	
70									9.0	
72									9.0	

标准工况塔式副臂载荷表 Standard Mode Tower Jib Lifting Load Chart

主臂长度 Boom length (m)		主臂60米 Boom length 60m								
塔臂长度 Tower Jib length (m)		24	30	36	42	48	54	60	66	72
幅度 Radius (m)	主臂角度 Boom angle (°)									
	75									
34	32.0									
36	29.0	28.0								
38	27.0	26.0	25.0							
40	25.0	24.0	23.0	22.0						
42		22.0	21.0	20.0	19.0					
44		21.0	19.0	18.0	17.0					
46			18.0	17.0	16.0	16.0				
48			17.0	15.0	15.0	14.0	14.0			
50			16.0	14.0	14.0	13.0	12.0			
52				13.0	13.0	12.0	11.0			
54				12.0	12.0	11.0	10.0	10.0	8.0	
56				11.0	11.0	10.0	9.0	9.0	7.0	
58					10.0	9.0	8.0	8.0	6.0	
60					9.0	8.0	7.0	7.0	6.0	
62						7.0	6.0	6.0	5.0	
64						7.0	6.0	6.0	4.0	
66						6.0	6.0	6.0	4.0	
68							5.0	5.0	3.0	
70							4.0	4.0	3.0	
72							4.0	3.0		

主臂长度 Boom length (m)		主臂60米 Boom length 60m								
塔臂长度 Tower Jib length (m)		24	30	36	42	48	54	60	66	72
幅度 Radius (m)	主臂角度 Boom angle (°)									
	65									
46	14.0									
48	12.0									
50	12.0	11.0								
52		10.0	9.0							
54		9.0	8.0							
56			7.0	6.0						
58			6.0	5.0						
60			6.0	4.0						
62				4.0	4.0					
64				3.0	3.0					
66				3.0						

超起工况重型主臂 SL Mode Heavy Boom

主臂长度 Boom length (m)	重型主臂中间节 Heavy boom insert		重型主臂拉板节 Heavy boom pedant section
	6m	12m	12m
36	-	-	1
42	1	-	1
48	2	-	1
54	1	1	1
60	2	1	1
66	1	2	1
72	2	2	1
78	1	3	1
84	2	3	1

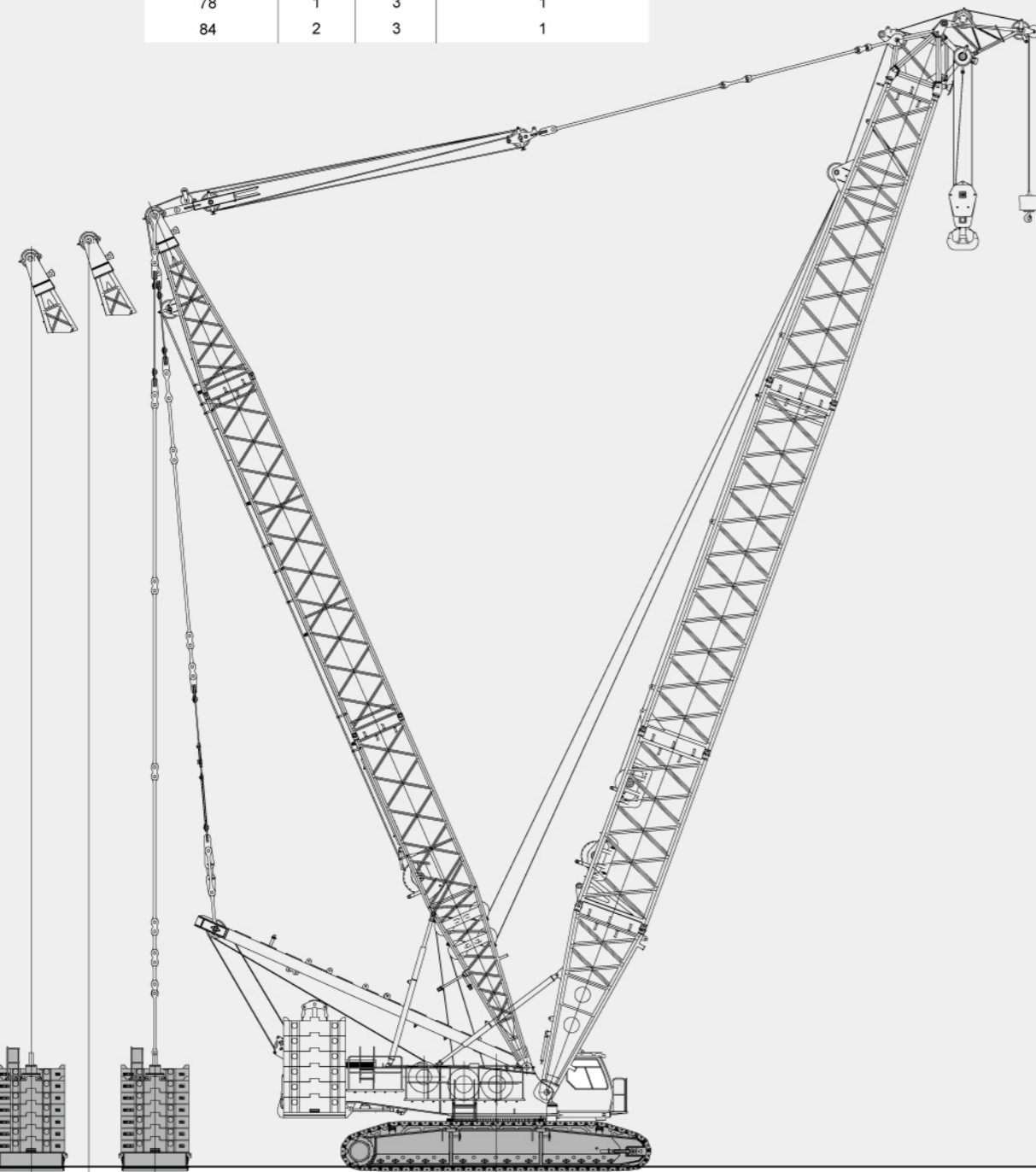

超起工况重型主臂作业范围 SL Mode Heavy Boom Working Area

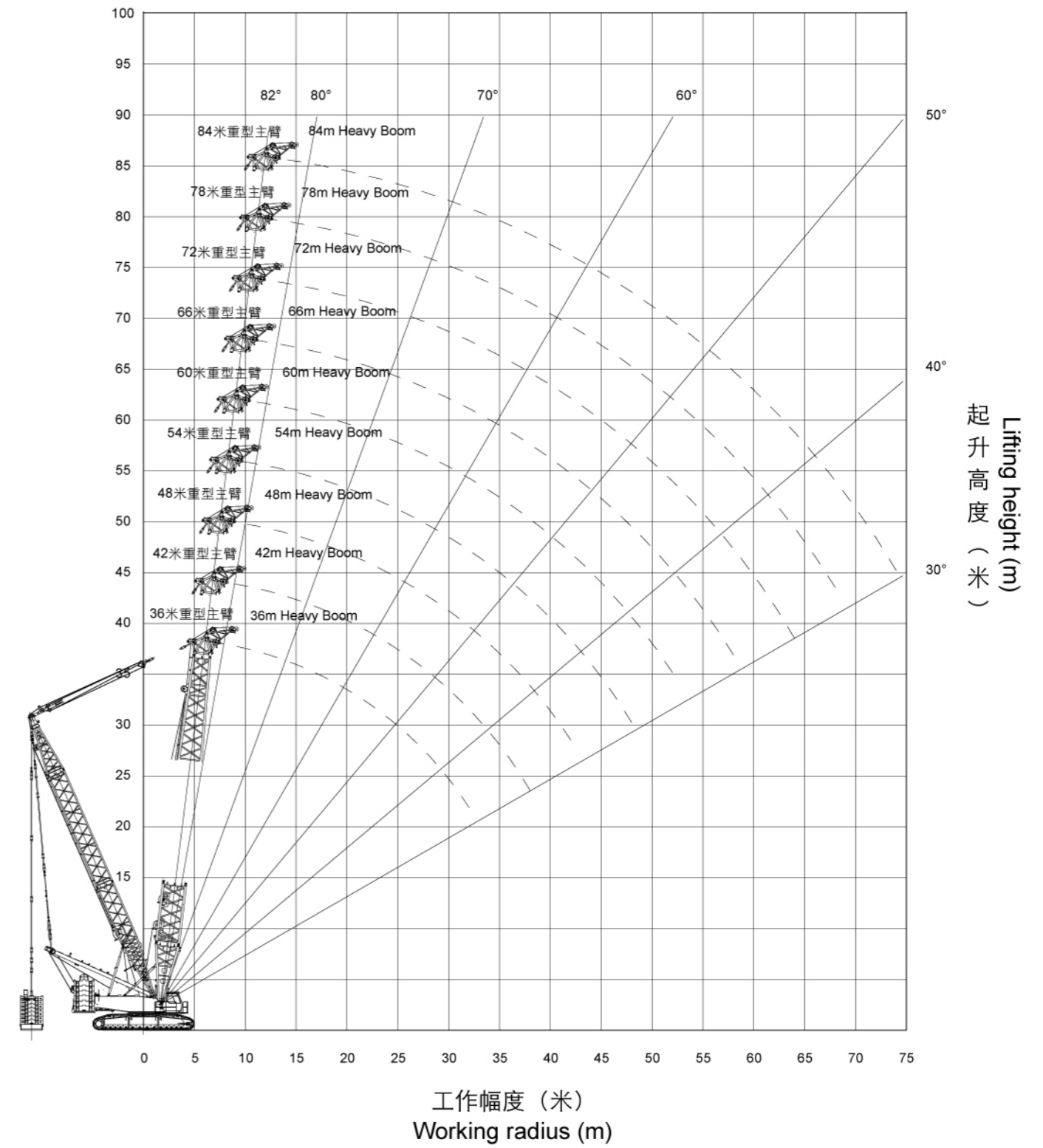

超起工况重型主臂载荷表 SL Mode Heavy Boom Lifting Load Chart

超起半径 SL Radius (m)	11								
	臂长 Boom length (m)								
幅度 Radius (m)	36	42	48	54	60	66	72	78	84
9	400.0								
10	400.0	370.0	334.0						
12	350.0	350.0	321.0	287.0	242.0*				
14	316.0	315.0	314.0	273.0	235.0	200.0*	160.0*		
16	276.0	275.0	274.0	270.0	234.0	199.0	162.0*	129.0*	102.0*
18	245.0	244.0	242.0	239.0	233.0	196.0	164.0	131.0*	104.0*
20	218.0	218.0	216.0	213.0	209.0	190.0	159.0	132.0*	105.0*
22	193.0	196.0	194.0	192.0	188.0	186.0	157.0	133.0	106.0*
24	172.0	179.0	176.0	174.0	171.0	169.0	154.0	129.0	106.0*
26	154.0	164.0	161.0	159.0	157.0	155.0	152.0	126.0	107.0
28	139.0	149.0	148.0	146.0	144.0	142.0	140.0	127.0	107.0
30	125.0	135.0	136.0	135.0	133.0	131.0	129.0	122.0	102.0
32	114.0	123.0	126.0	125.0	123.0	122.0	120.0	118.0	100.0
34		112.0	116.0	116.0	115.0	114.0	112.0	110.0	100.0
36		102.0	108.0	107.0	107.0	106.0	104.0	102.0	97.0
38		93.0	100.0	100.0	99.0	99.0	97.0	96.0	94.0
40			92.0	94.0	93.0	92.0	91.0	90.0	88.0
42			85.0	88.0	87.0	87.0	86.0	85.0	83.0
44				83.0	82.0	81.0	81.0	80.0	78.0
46				77.0	77.0	77.0	76.0	75.0	73.0
48				71.0	73.0	72.0	72.0	71.0	69.0
50					69.0	69.0	68.0	67.0	66.0
52					65.0	65.0	64.0	63.0	62.0
54					62.0	62.0	61.0	60.0	59.0
56						59.0	58.0	57.0	56.0
58						55.0	55.0	54.0	53.0
60							52.0	51.0	50.0
62							50.0	49.0	48.0
64							47.0	47.0	45.0
66								45.0	43.0
68								43.0	41.0
70								41.0	39.0
72									37.0
74									35.0

注：起重性能带*号，说明此工况下超起配重不能离地。

Note: The data with * mark means that SL counterweight can not be clear off the ground.

超起工况重型主臂载荷表 SL Mode Heavy Boom Lifting Load Chart

超起半径 SL Radius (m)	15								
	臂长 Boom length (m)								
幅度 Radius (m)	36	42	48	54	60	66	72	78	84
9	400.0								
10	400.0	380.0	327.0*						
12	370.0	350.0	318.0*	281.0*	237.0*				
14	350.0	350.0	316.0	271.0*	237.0*	190.0*	151.0*		
16	322.0	319.0	314.0	270.0	232.0*	192.0*	153.0*	123.0*	97.0*
18	286.0	281.0	277.0	269.0	227.0	194.0*	155.0*	124.0*	98.0*
20	255.0	251.0	248.0	244.0	222.0	185.0*	156.0*	125.0*	99.0*
22	228.0	227.0	223.0	220.0	217.0	186.0	157.0*	126.0*	100.0*
24	200.0	206.0	200.0	201.0	197.0	182.0	150.0*	127.0*	100.0*
26	183.0	189.0	186.0	183.0	181.0	178.0	149.0	127.0*	100.0*
28	165.0	174.0	171.0	169.0	167.0	164.0	149.0	123.0*	100.0*
30	149.0	160.0	158.0	156.0	154.0	152.0	144.0	120.0	100.0*
32	136.0	146.0	147.0	145.0	143.0	141.0	139.0	119.0	100.0*
34		134.0	137.0	136.0	134.0	132.0	130.0	119.0	98.0*
36		122.0	128.0	127.0	125.0	123.0	121.0	116.0	94.0
38		112.0	119.0	119.0	117.0	116.0	114.0	112.0	94.0
40			110.0	111.0	111.0	109.0	107.0	106.0	94.0
42			102.0	105.0	104.0	103.0	101.0	99.0	94.0
44				99.0	98.0	97.0	95.0	94.0	92.0
46				93.0	92.0	92.0	90.0	89.0	87.0
48				86.0	87.0	87.0	86.0	84.0	83.0
50					83.0	82.0	81.0	80.0	78.0
52					79.0	78.0	77.0	76.0	74.0
54					76.0	74.0	73.0	72.0	70.0
56						71.0	70.0	69.0	67.0
58						67.0	67.0	65.0	64.0
60							63.0	62.0	61.0
62							61.0	59.0	58.0
64							58.0	57.0	56.0
66								54.0	53.0
68								52.0	51.0
70								51.0	48.0
72									46.0
74									44.0

注：起重性能带*号，说明此工况下超起配重不能离地。

Note: The data with * mark means that SL counterweight can not be clear off the ground.

超起工况轻型主臂 SL Mode Light Boom

超起工况轻型主臂作业范围 SL Mode Light Boom Working Area

主臂长度 Boom length (m)	重型主臂中间节 Heavy boom insert 12m	塔臂中间节 Tower jib insert	
		6m	12m
78	4	-	-
84	4	1	-
90	4	-	1
96	4	1	1
102	4	2	1
108	4	1	2
114	4	-	3
120	4	1	3

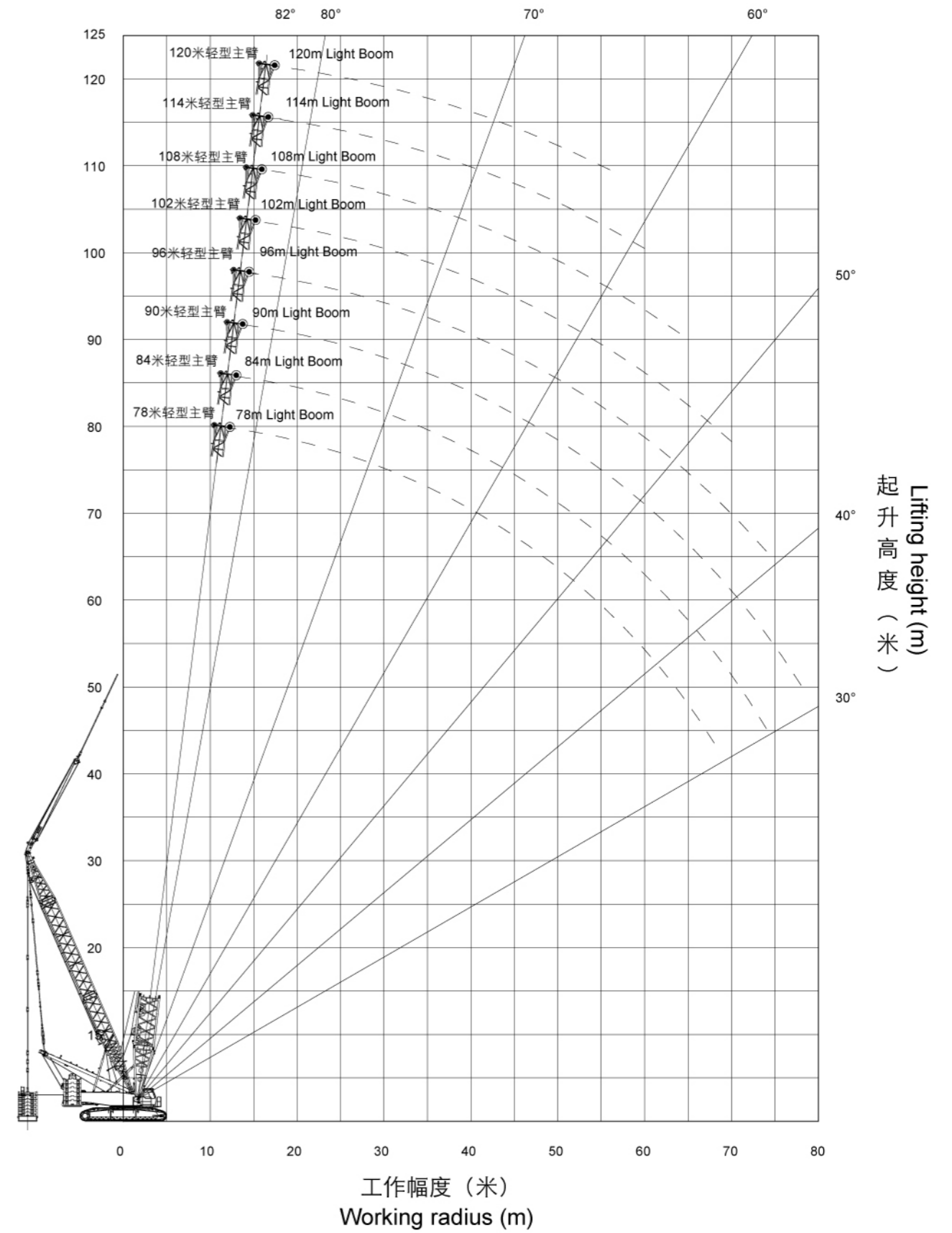
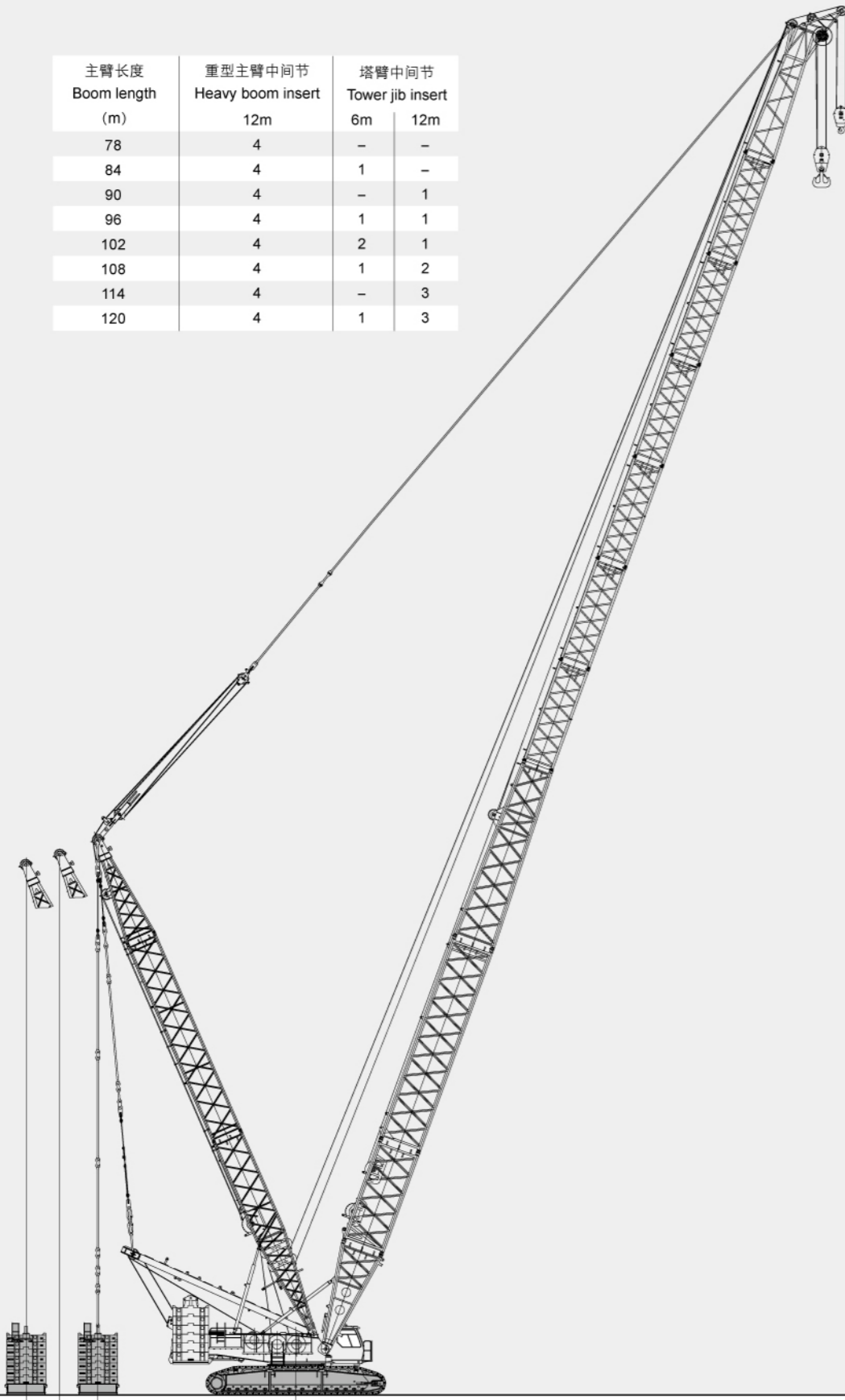

超起工况轻型主臂载荷表 SL Mode Light Boom Lifting Load Chart

超起半径 SL Radius (m)	11							
	臂长 Boom length (m)							
幅度 Radius (m)	78	84	90	96	102	108	114	120
16	130.0*							
18	131.0*	104.0*	82.0*					
20	133.0*	105.0*	82.0*	66.0*	49.0*			
22	134.0	106.0*	83.0*	70.0*	50.0*	40.0*	26.0*	
24	134.0	107.0*	84.0*	69.0*	50.0*	40.0*	26.0*	21.0*
26	135.0	107.0	84.0*	69.0*	51.0*	41.0*	27.0*	21.0*
28	136.0	108.0	87.0*	68.0*	51.0*	41.0*	32.0*	21.0*
30	129.0	108.0	88.0*	68.0*	54.0*	41.0*	33.0*	21.0*
32	119.0	102.0	80.0*	66.0*	52.0*	41.0*	33.0*	21.0*
34	110.0	96.0	75.0*	62.0*	48.0*	41.0*	33.0*	21.0*
36	102.0	90.0	70.0*	53.0*	45.0*	37.0*	26.0*	21.0*
38	95.0	81.0	66.0*	49.0*	41.0*	34.0*	24.0*	20.0*
40	89.0	76.0	61.0*	46.0*	38.0*	26.0*	21.0*	17.0*
42	84.0	72.0	53.0*	42.0*	35.0*	23.0*	19.0*	15.0*
44	79.0	68.0	49.0*	39.0*	26.0*	21.0*	16.0*	12.0*
46	74.0	64.0	46.0*	36.0*	24.0*	18.0*	14.0*	10.0*
48	70.0	60.0	43.0*	33.0*	21.0*	16.0*	12.0*	8.0*
50	66.0	52.0	40.0*	25.0*	19.0*	14.0*	10.0*	7.0*
52	63.0	49.0	37.0*	23.0*	17.0*	12.0*	8.0*	5.0*
54	60.0	46.0	35.0*	21.0*	15.0*	10.0*	7.0*	
56	57.0	43.0	26.0*	19.0*	13.0*	8.0*	5.0*	
58	54.0	41.0	24.0*	17.0*	11.0*	7.0*		
60	51.0	38.0	22.0*	15.0*	10.0*	5.0*		
62	49.0	35.0	20.0*	13.0*	8.0*	4.0*		
64	46.0	33.0	18.0*	11.0*	7.0*			
66	43.0	25.0*	17.0*	10.0*				
68	40.0	23.0*	15.0*	8.0*				
70		21.0*	13.0*	7.0*				
72		19.0*	11.0*	5.0*				
74		18.0*	10.0*	4.0*				
76			9.0*					
78			7.0*					

注：起重性能带*号，说明此工况下超起配重不能离地。

Note: The data with * mark means that SL counterweight can not be clear off the ground.

超起工况轻型主臂载荷表 SL Mode Light Boom Lifting Load Chart

超起半径 SL Radius (m)	15							
	臂长 Boom length (m)							
幅度 Radius (m)	78	84	90	96	102	108	114	120
16	123.0*							
18	124.5*	99.0*	80.5*					
20	125.5*	99.5*	80.0*	62.5*	47.0*			
22	126.5*	100.0*	80.0*	63.5*	47.5*	37.5*	24.5*	
24	127.5*	100.0*	79.0*	63.5*	47.5*	38.0*	25.0*	19.0*
26	127.5*	100.0*	79.5*	64.0*	48.0*	38.5*	25.0*	19.5*
28	128.0*	100.0*	80.0*	67.0*	48.0*	38.5*	25.5*	19.5*
30	127.5	100.0*	80.0*	66.5*	48.5*	39.0*	25.5*	19.5*
32	127.5	100.0*	80.0*	66.0*	48.5*	39.0*	25.5*	20.0*
34	128.0	100.0*	79.5*	65.5*	48.5*	39.0*	25.5*	20.0*
36	121.5	95.5*	74.5*	61.5*	48.0*	39.0*	26.0*	20.0*
38	113.5	89.5*	69.0*	52.0*	44.0*	36.5*	26.0*	20.0*
40	106.0	79.5*	64.5*	48.5*	40.5*	33.5*	23.0*	19.0*
42	99.5	74.5*	60.5*	45.0*	37.0*	25.0*	20.5*	16.5*
44	94.0	70.0*	51.5*	41.5*	34.0*	22.5*	18.0*	14.0*
46	88.5	66.0*	48.0*	38.0*	25.5*	20.0*	15.5*	11.5*
48	79.0	61.5*	45.0*	35.0*	23.0*	17.5*	13.5*	9.5*
50	74.5	53.0*	41.5*	26.0*	20.5*	15.0*	11.5*	7.5*
52	70.0	49.5*	38.5*	23.5*	18.5*	13.0*	9.5*	6.0*
54	66.0	46.5*	35.5*	21.5*	16.0*	11.0*	7.5*	4.0*
56	62.0	43.5*	33.0*	19.5*	14.0*	9.0*	6.0*	
58	53.5	40.5*	24.5*	17.0*	12.0*	7.5*	4.0*	
60	50.5	37.5*	22.5*	15.0*	10.0*	6.0*		
62	47.5	35.0*	20.5*	13.5*	8.5*	4.0*		
64	44.0*	26.5*	18.5*	11.5*	7.0*			
66	41.0*	24.5*	16.5*	10.0*				
68	38.0*	22.5*	14.5*	8.5*				
70		20.5*	13.0*	7.0*				
72		18.5*	11.0*					
74		16.5*	9.5*					
76			8.0*					
78			7.0*					

注：起重性能带*号，说明此工况下超起配重不能离地。

Note: The data with * mark means that SL counterweight can not be clear off the ground.

超起工况塔式副臂 SL Mode Tower Jib

超起工况塔式副臂作业范围 SL Mode Tower Jib Working Area

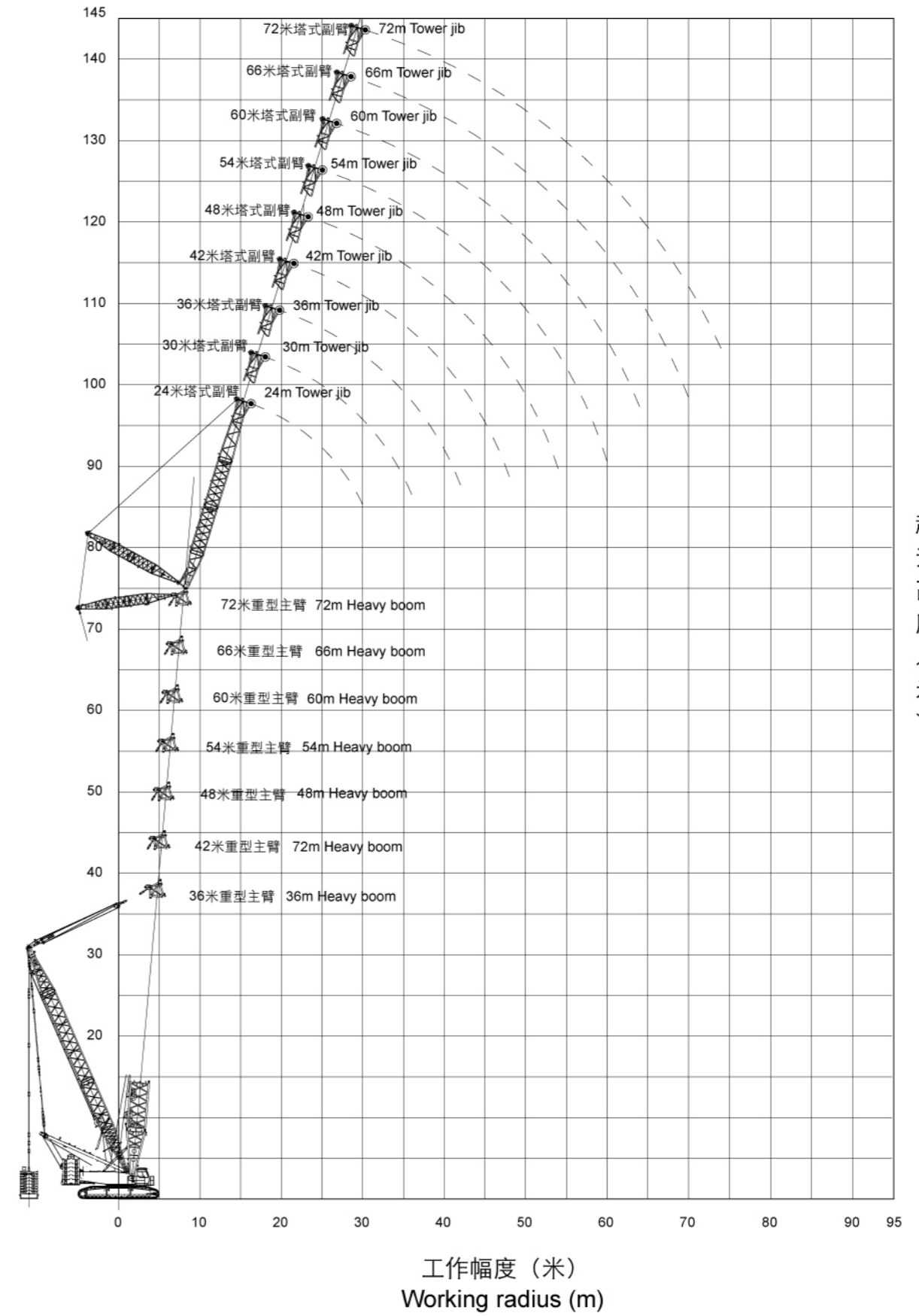
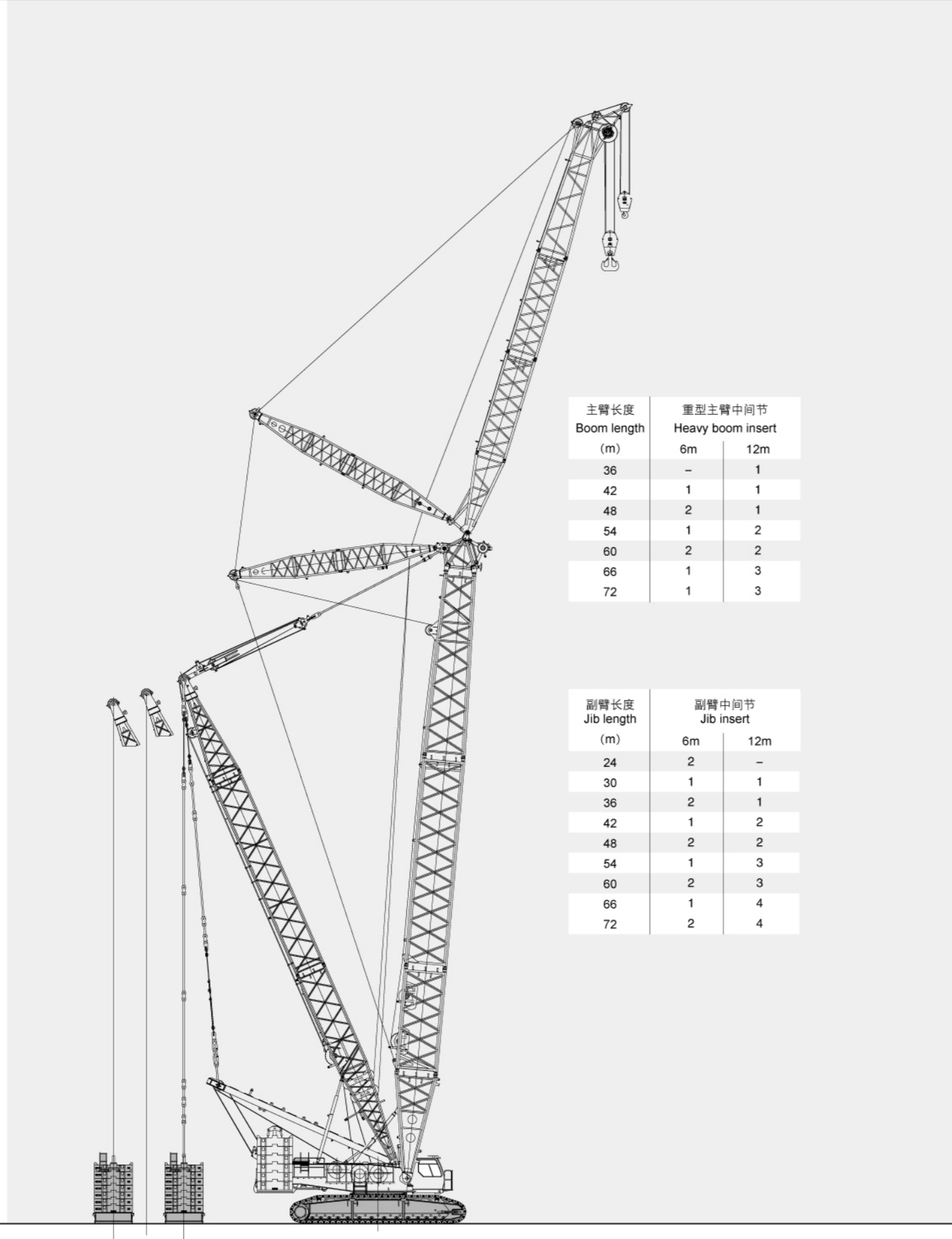

超起工况塔式副臂载荷表 SL Mode Tower Jib Lifting Load Chart

主臂长度 Boom length (m)		主臂36米 Boom length 36m					
塔式副臂长度 Tower jib length (m)		24					
超起平衡半径 SL counterweight radius (m)		15					
超起平衡重量 SL counterweight weight (t)		0	40	80	120	160	200
幅度 Radius (m)	主臂角度 Boom angle (°)						
	85						
12	150.0	181.0	181.0	181.0*	181.0*	181.0*	
14	129.0	153.0	178.0	178.0*	178.0*	178.0*	
16	112.0	143.0	174.0	174.0	174.0*	174.0*	
18	99.0	131.0	163.0	163.0	163.0*	163.0*	
20	88.0	119.0	151.0	151.0	151.0*	151.0*	
22	80.0	105.0	130.0	130.0	130.0*	130.0*	
24	73.0	92.0	112.0	112.0*	112.0*	112.0*	
26	66.0	81.0	96.0	96.0*	96.0	96.0	
28	61.0	70.0	80.0	80.0*	80.0	80.0	

主臂长度 Boom length (m)		主臂36米 Boom length 36m					
塔式副臂长度 Tower jib length (m)		24					
超起平衡半径 SL counterweight radius (m)		15					
超起平衡重量 SL counterweight weight (t)		0	40	80	120	160	200
幅度 Radius (m)	主臂角度 Boom angle (°)						
	75						
24	65.0	85.0	106.0	127.0	148.0	148.0*	
26	60.0	80.0	100.0	120.0	140.0	140.0*	
28	55.0	72.0	90.0	107.0	125.0	125.0*	
30	51.0	65.0	79.0	93.0	108.0	108.0*	
32	47.0	58.0	69.0	80.0	92.0*	92.0*	
34	44.0	55.0	66.0	77.0	88.0*	88.0*	

注：起重性能带*号，说明此工况下超起配重不能离地。

Note: The data with * mark means that SL counterweight can not be clear off the ground.

超起工况塔式副臂载荷表 SL Mode Tower Jib Lifting Load Chart

主臂长度 Boom length (m)		主臂36米 Boom length 36m					
塔式副臂长度 Tower jib length (m)		24					
超起平衡半径 SL counterweight radius (m)		15					
超起平衡重量 SL counterweight weight (t)		0	40	80	120	160	200
幅度 Radius (m)	主臂角度 Boom angle (°)						
	65						
34	39.0	51.0	63.0	75.0	87.0	99.0*	
36	36.0	47.0	58.0	69.0	80.0*	92.0*	
38	34.0	43.0	53.0	62.0	72.0*	82.0*	

主臂长度 Boom length (m)		主臂72米 Boom length 72m					
塔式副臂长度 Tower jib length (m)		72					
超起平衡半径 SL counterweight radius (m)		15					
超起平衡重量 SL counterweight weight (t)		0	40	80	120	160	200
幅度 Radius (m)	主臂角度 Boom angle (°)						
	85						
30	23.0	25.0*	25.0*	25.0*	25.0*	25.0*	
32	22.0	24.0*	24.0*	24.0*	24.0*	24.0*	
34	21.0	22.0*	22.0*	22.0*	22.0*	22.0*	
36	20.0	21.0*	21.0*	21.0*	21.0*	21.0*	
38	19.0	20.0*	20.0*	20.0*	20.0*	20.0*	
40	18.0	19.0*	19.0*	19.0*	19.0*	19.0*	
42	18.0	19.0	19.0*	19.0*	19.0*	19.0*	
44	17.0	18.0	18.0*	18.0*	18.0*	18.0*	
46	17.0	18.0	18.0*	18.0*	18.0*	18.0*	
48	16.0	17.0	17.0*	17.0*	17.0*	17.0*	
50	16.0	17.0	17.0*	17.0*	17.0*	17.0*	
52	15.0	16.0	16.0*	16.0*	16.0*	16.0*	
54	15.0	16.0	16.0*	16.0*	16.0*	16.0*	
56	14.0	15.0	15.0*	15.0*	15.0*	15.0*	
58	14.0	15.0	15.0*	15.0*	15.0*	15.0*	
60	13.0	14.0	14.0*	14.0*	14.0*	14.0*	
62	12.0	14.0	14.0*	14.0*	14.0*	14.0*	
64	12.0	13.0	13.0*	13.0*	13.0*	13.0*	
66	11.0	13.0	13.0*	13.0*	13.0*	13.0*	
68	10.0	12.0	12.0*	12.0*	12.0*	12.0*	
70	10.0	12.0	12.0*	12.0*	12.0*	12.0*	
72	9.0	11.0	11.0*	11.0*	11.0*	11.0*	
74	9.0	11.0	11.0*	11.0*	11.0*	11.0*	

注：起重性能带*号，说明此工况下超起配重不能离地。

Note: The data with * mark means that SL counterweight can not be clear off the ground.

超起工况塔式副臂载荷表

SL Mode Tower Jib Lifting Load Chart

主臂长度 Boom length (m)		主臂72米 Boom length 72m					
塔式副臂长度 Tower jib length (m)		72					
超起平衡重半径 SL counterweight radius (m)		15					
超起平衡重重量 SL counterweight weight (t)		0	40	80	120	160	200
幅度 Radius (m)	主臂角度 Boom angle (°)						
	75						
54	8.0	15.0	20.0	20.0*	20.0*	20.0*	20.0*
56	7.0	14.0	19.0	19.0*	19.0*	19.0*	19.0*
58	6.0	13.0	18.0	18.0*	18.0*	18.0*	18.0*
60	5.0	12.0	17.0	17.0*	17.0*	17.0*	17.0*
62	5.0	12.0	16.0	16.0*	16.0*	16.0*	16.0*
64	4.0	11.0	16.0	16.0*	16.0*	16.0*	16.0*
66	4.0	11.0	15.0	15.0*	15.0*	15.0*	15.0*
68	3.0	10.0	15.0	15.0*	15.0*	15.0*	15.0*
70	3.0	10.0	14.0	14.0*	14.0*	14.0*	14.0*

注：起重性能带*号，说明此工况下超起配重不能离地。

Note: The data with * mark means that SL counterweight can not be clear off the ground.

载荷表说明：

- 载荷表中额定起重量，指在给定的臂架长度、工作幅度条件下，重物自由悬挂，在坚实、平坦地面作业所能保证的最大起重量。作业者须视各种不良条件（如地面松软或不平、风力、侧面负荷、摆动作用、多台起重机合力起吊）限制或降低起重机的起重量；
- 载荷表中额定起重量包括吊钩、钢丝绳、和其它所有吊具的重量；
- 载荷表中没有列出额定值的空白区，不允许将起重机用于该区所对应的起重作业；
- 载荷表中起重量为带上车全配重和下车全配重的起重量；
- 使用主臂和塔臂可以配置臂端单滑轮机构，臂端单滑轮机构的起重量为性能表中相应的额定起重量减去臂端单滑轮机构、12t吊钩和吊具的重量；
- 臂端单滑轮机构的最大起重量（包括吊钩、吊具和起升钢丝绳）不准超过12t，性能载荷表中的额定起重量小于12t时按性能表起吊。

Notes on Lifting Load Chart:

- The total rated lifting loads shown in above tables are the max. lifting capacity based on the condition that crane set up on firm and level ground with given boom length, radius and load, crane operator shall limit or reduce lifting loads according to variable working conditions (soft or uneven ground, wind, side loading, slewing action, lifting with one more cranes).
- The total rated lifting loads include the weight of hook block, wire rope and other slings.
- The blank area in above tables means crane operation is not allowed corresponding to these areas.
- The total rated lifting loads are the lifting capacity for the crane with superstructure counterweight and carrier counterweight.
- Boom can be equipped with a boom tip single sheave, which lifting load is the total rated lifting loads in above table decrease the weight of single sheave, 12t capacity hook block and slings.
- The max. rated lifting load for single top is 12t (include the weight of hook block, slings and hoist wire rope), if rated lifting load in above tables is less than 12t, load lifting is according to the table.