

NATIONAL CRANE®

400B Product Guide

ASME B30.5 • Imperial 85%



Features

- 9,1 t (10 USt) rating
- 17,1 m (56 ft) three-section boom
- Multiple mounting configurations
- Internal anti-two block

NATIONAL CRANE 400B

The 400B Series delivers 9,07 t (10 USt) maximum capacity and a 19,8 m (65 ft) maximum vertical hydraulic reach with main boom.

Features

> Main boom

With multiple boom length options including the class leading 17,07m (56 ft) boom length, the 400B has the strength and capacity you need to tackle the toughest jobs, while in a compact crane.

> Multiple Mounting Configurations

The 400B offers tremendous flexibility in mounting configurations to tailor to specific applications. Standard mount (crane frame located behind truck cab), Rear Mount (crane frame located at the rear of the truck frame), and Tractor Mount (crane frame located at the center of a short wheelbase truck frame equipped with a fifth wheel) are all available. This allows optimization of the crane to better suit the needs of the job - whether hauling construction materials on the flatbed, delivering and placing pre-cast concrete components, or hauling a flatbed trailer.

> Dual side control station

Traditional mechanical control levers and layout with an operator station located on both sides of the crane. Smooth operating hydraulic control system allows for optimum multi-functioning for all crane functions as well as outrigger control. Automotive switches and wiring allows for reliable performance and control. Electronic engine start/stop switches with foot pedal throttle control at each side. The integrated Hydraulic Capacity Alert (HCA) system provides real-time feedback to the operator about capacity, and anti-two-block (ATB) status via gauges and indicator lights located at each control station.

> Outriggers

Multiple outrigger configurations available for each mounting configurations to best handle the job at hand. From standard "A-frame" style outriggers, to over-frame mounted "out and down" style, flexibility is designed in. Outriggers are equipped with fixed floats and a level indicator (sight bubble) is located at the operator stations.

> Options and Lift Solutions

- Hydraulic hose reels
- Factory installed tool box options
- Bulkhead and flat-bed options
- One-option hydraulic tool circuit



Jobsite benefits

- > Boost productivity with the compact, simple to operate and versatile 400B
- > Class-leading tip height when equipped with the 17,07 m (56 ft) three-section boom
- > Utilization enhancing options such as a personnel platform, wireless radio remotes or hydraulic tool circuits for optimum versatility.
- > Internal anti-two-block wire routing eliminates potential for damage
- > Pre-painted components reduce the possibility of rust, improve serviceability and enhance the appearance of the machine



Manitowoc Crane Care when you need it.
The assurance of the world's most advanced crane service and support to get you back to work fast.



Manitowoc Finance helps you get right to work generating profits for your business.
Financial tools that help you capitalize on opportunity with solutions that fit your needs.

Contents

- Dimensions 5
- Mounting configurations 6
- Working range - 31,39 m (37 ft) boom 8
- Load chart - 31,39 m (37 ft) boom 9
- Working range - 14,02 m (46 ft) boom 10
- Load chart - 14,02 m (46 ft) boom 11
- Working range - 17,07 m (56 ft) boom 12
- Load chart - 17,07 m (56 ft) boom 13
- Specifications 14
- Symbols glossary 17

Dimensions

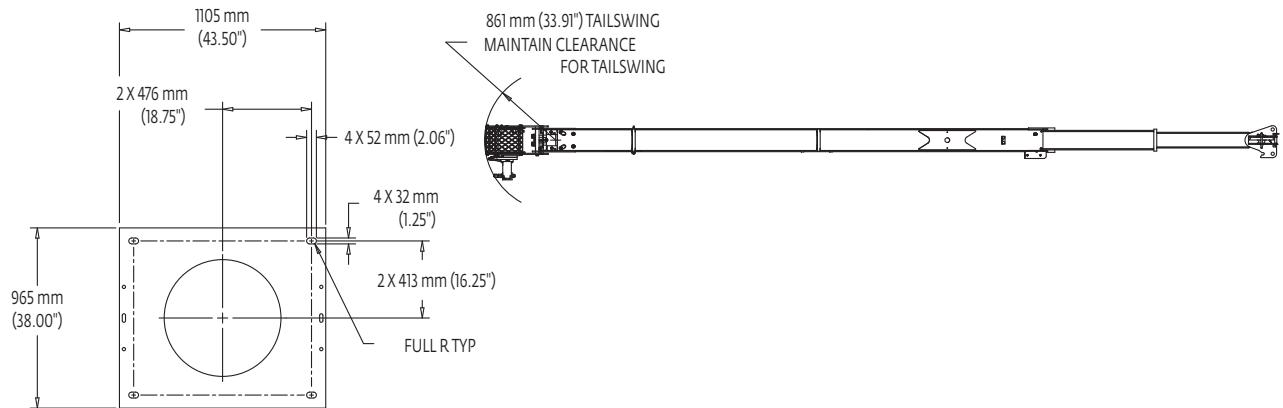

FRAME BASE PLATE
SCALE 1:12

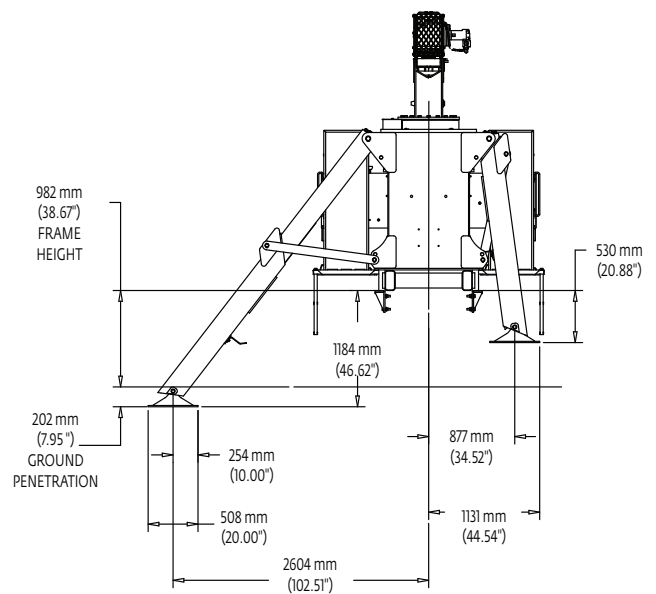
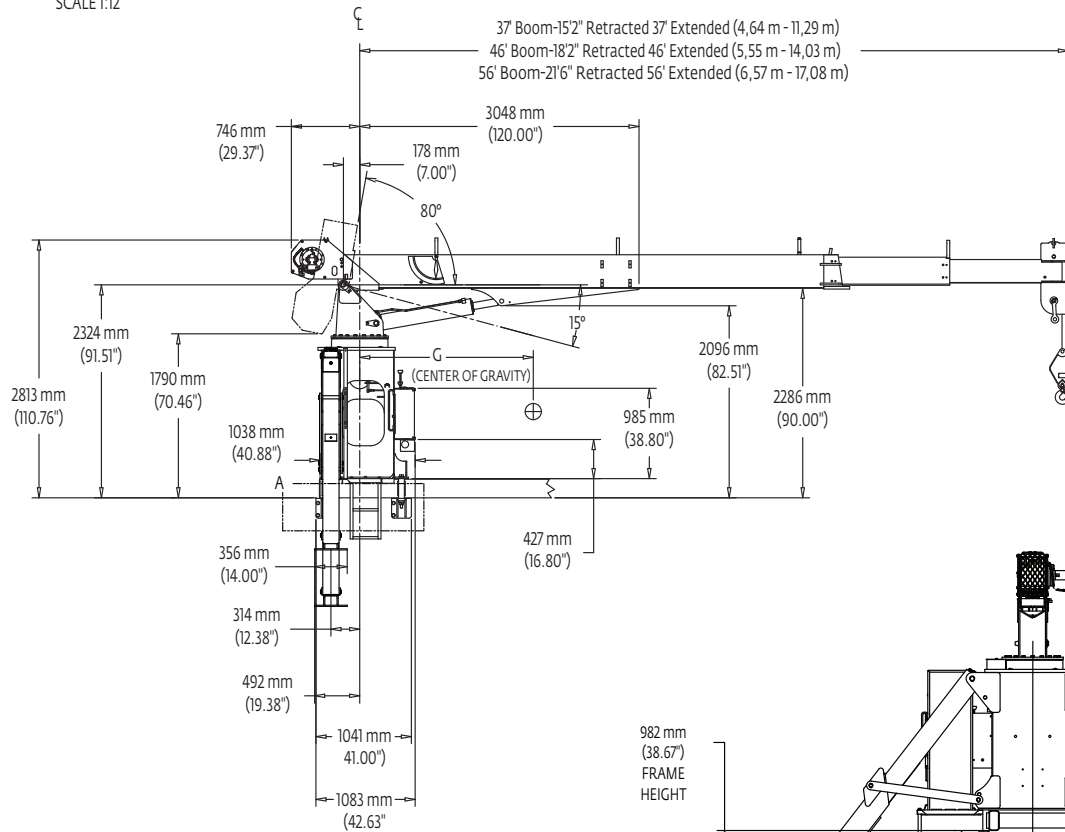

Series	G	Dry weight	With oil weight
456B	1194 mm (47 in)	3675 kg (8100 lb)	3825 kg (8425 lb)
446B	914 mm (36 in)	3525 kg (7775 lb)	3675 kg (8100 lb)
437B	737 mm (29 in)	3375 kg (7450 lb)	3525 kg (7775 lb)

*Above weights do not include sub-base, rear stabilizers, PTO, pump, boom rests or options

Mounting configurations

The configurations are based on the Series 400B with an 85% stability factor. The complete unit must be installed in accordance with factory requirements and a test performed to determine actual stability and counterweight requirements since individual truck chassis vary.

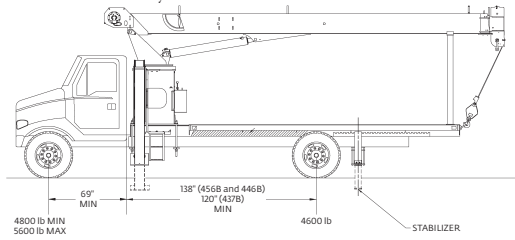

	Configuration 1 with Sub-base
Working area.....	180°
Gross Axle Weight Rating Front.....	4082 kg (9000 lb)
Gross Axle Weight Rating Rear.....	8618 kg (19,000 lb)
Gross Vehicle Weight Rating.....	12 700 kg (28,000 lb)
Wheelbase.....	650 cm (184 in) on 437B, 526 cm (207 in) on 446B, 456B
Cab to Axle/trunnion (CA/CT).....	305 cm (120 in) on 437B, 351 cm (138 in) on 446B, 456B
Frame Section Modulus (SM) under crane with 758 MPa (110,000 PSI).....	164 cm ³ (10.0 in ³)
Frame Section Modulus (SM) over rear stabilizers: 758 MPa (110,000 PSI).....	164 cm ³ (10.0 in ³)
Stability Weight, Front.....	2177 kg (4800 lb) minimum, 2540 kg (5600 lb) maximum*
Stability Weight, Rear.....	2087 kg (4600 lb) minimum*
Estimated Average Final Weight.....	9524 kg (21,000 lb)**

Allows the installation of Series 400B on a chassis with small frame by using standard sub-base. In most cases, chassis will not require reinforcing and counterweight will not be required. This configuration gives a payload of app. 2722 kg (6000 lb) on minimum truck. Requires standard sub-base and rear stabilizers. Full capacity work area in rear 180° of vehicle from outrigger to outrigger.

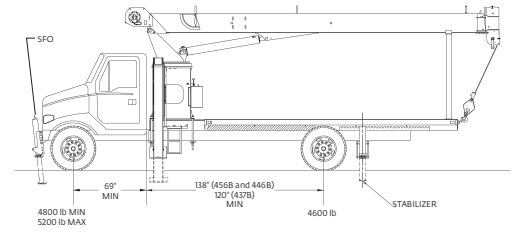

	Configuration 2 with Sub-base and SFO
Working area.....	360°
Gross Axle Weight Rating Front.....	4082 kg (9000 lb)
Gross Axle Weight Rating Rear.....	8618 kg (19,000 lb)
Gross Vehicle Weight Rating.....	12 700 kg (28,000 lb)
Wheelbase.....	650 cm (184 in) on 437B, 526 cm (207 in) on 446B, 456B
Cab to Axle/trunnion (CA/CT).....	305 cm (120 in) on 437B, 351 cm (138 in) on 446B, 456B
Frame Section Modulus (SM) under crane w/ 758 MPa (110,000 PSI).....	164 cm ³ (10.0 in ³)
Frame Section Modulus (SM) over rear stabilizers: 758 MPa (110,000 PSI).....	164 cm ³ (10.0 in ³)
Stability Weight, Front.....	2177 kg (4800 lb) minimum, 2359 kg (5200 lb) maximum*
Stability Weight, Rear.....	2087 kg (4600 lb) minimum*
Estimated Average Final Weight.....	9707 kg (21,400 lb)**

Requires front stabilizer for full capacity 360° around the truck. Requires front and rear stabilizers and standard sub-base. Front stabilizer for this configuration requires 13.5 inch³ (50,000 PSI), or 6.2 inch³ (110,000 PSI) section modulus from back of the front spring hangers through front suspension and to the front stabilizer. Normally a tapered front frame cannot be reinforced to these minimums.

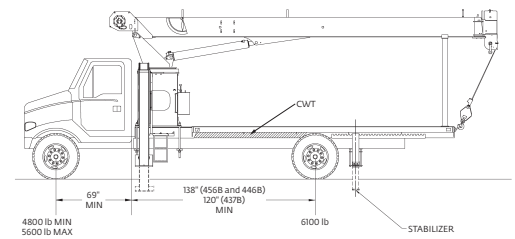

	Configuration 3 with Sub-base and Counterweight
Working area.....	360°
Gross Axle Weight Rating Front.....	4082 kg (9000 lb)
Gross Axle Weight Rating Rear.....	8618 kg (19,000 lb)
Gross Vehicle Weight Rating.....	12 700 kg (28,000 lb)
Wheelbase.....	650 cm (184 in) on 437B, 526 cm (207 in) on 446B, 456B
Cab to Axle/trunnion (CA/CT).....	305 cm (120 in) on 437B, 351 cm (138 in) on 446B, 456B
Frame Section Modulus (SM) under crane w/ 758 MPa (110,000 PSI).....	164 cm ³ (10.0 in ³)
Frame Section Modulus (SM) over rear stabilizers: 758 MPa (110,000 PSI).....	164 cm ³ (10.0 in ³)
Stability Weight, Front.....	2177 kg (4800 lb) minimum, 2540 kg (5600 lb) maximum*
Stability Weight, Rear.....	2767 kg (6100 lb) minimum*
Estimated Average Final Weight.....	10 206 kg (22,500 lb)**

Allows 360° stability at full capacity without front stabilizer. Requires additional weight at rear of the truck to reduce loading on the front axle when lifting over the front of the vehicle. If continually lifting over the front, the vehicle must be equipped with front stabilizer to eliminate fatigue on front axle components. Requires rear stabilizers and standard sub-base with counterweight in sub-base or underside of bed.

Mounting configurations

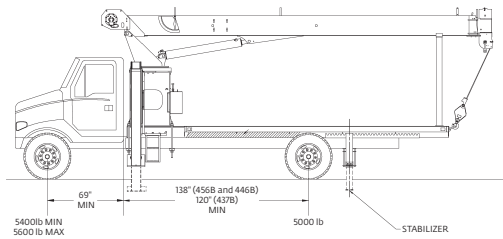

The Series 400B can be mounted without the factory-furnished sub-base provided the truck is above minimum specifications for truck frame strength and chassis weight. A 400B mounted in this manner will be 180° stable over the rear of the vehicle from outrigger to outrigger.

	Configuration 4 without Sub-base
Working area.....	180°
Gross Axle Weight Rating Front.....	4082 kg (9000 lb)
Gross Axle Weight Rating Rear.....	8618 kg (19,000 lb)
Gross Vehicle Weight Rating.....	12 700 kg (28,000 lb)
Wheelbase.....	650 cm (184 in) on 437B, 526 cm (207 in) on 446B, 456B
Cab to Axle/trunnion (CA/CT).....	305 cm (120 in) on 437B, 351 cm (138 in) on 446B, 456B
Frame Section Modulus (SM) under crane w/ 758 MPa (110,000 PSI).....	246 cm ³ (15.0 in ³)
Frame Section Modulus (SM) over rear stabilizers: 758 MPa (110,000 PSI).....	164 cm ³ (10.0 in ³)
Stability Weight, Front.....	2177 kg (5400 lb) minimum, 2540 kg (5600 lb) maximum*
Stability Weight, Rear.....	2268 kg (5000 lb) minimum*
Estimated Average Final Weight.....	10 206 kg (22,500 lb)**

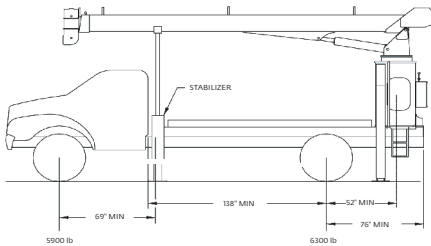

The advantages of a rear-mounted Series 400B are: (1) it allows the operator to effectively use the close-in working area to lift heavier loads, and (2) 360° solid stability at full rated load. Counterweight up to 3000 lb will be required on a minimum truck. With this configuration, a payload of approximately 3500 lb (1588 kg) can be hauled on a minimum truck. Underframe stabilizers behind the cab may interfere with the drive line or cause ground clearance problems. If so, contact the factory for alternatives.

	Configuration 5 - Rear Mount with HD Sub-base
Working area.....	360°
Gross Axle Weight Rating Front.....	4082 kg (9000 lb)
Gross Axle Weight Rating Rear.....	8618 kg (19,000 lb)
Gross Vehicle Weight Rating.....	12 700 kg (28,000 lb)
Wheelbase.....	526 cm (207 in)
Cab to Axle/trunnion (CA/CT).....	351 cm (138 in)
After Frame (AF).....	193 cm (76 in) minimum
Frame Section Modulus (SM) under crane w/ 758 MPa (110,000 PSI).....	213 cm ³ (13.0 in ³)
Frame Section Modulus (SM) over rear stabilizers: 758 MPa (110,000 PSI).....	213 cm ³ (13.0 in ³)
Stability Weight, Front.....	2676 kg (5900 lb) minimum*
Stability Weight, Rear.....	3084 kg (6800 lb) minimum*
Estimated Average Final Weight.....	11 113 kg (24,500 lb)**

Notes:

- Gross Vehicle Weight rating (GVWR) is dependent on all components of the vehicle (axles, tires, springs, frame, etc.) meeting manufacturers' recommendations; always specify GVWR when purchasing trucks
- Diesel engines require a variable speed governor and energize-to-run fuel solenoid for smooth crane operation; electronic fuel injection requires EET engine remote throttle
- All mounting data is based on a National Crane Series 400B with an 85% factor
- The complete unit must be installed in accordance with factory requirements, and a test performed to determine actual stability and counterweight requirements per SAE J765; contact the factory for details
- Transmission neutral safety interlock switch is required

**Estimated axle scale rates prior to installation of crane, stabilizers and sub-base for 85% stability.*

Working range

 11,28 m
(37 ft)

 100%
7,52 m
(24.7 ft)

 360°

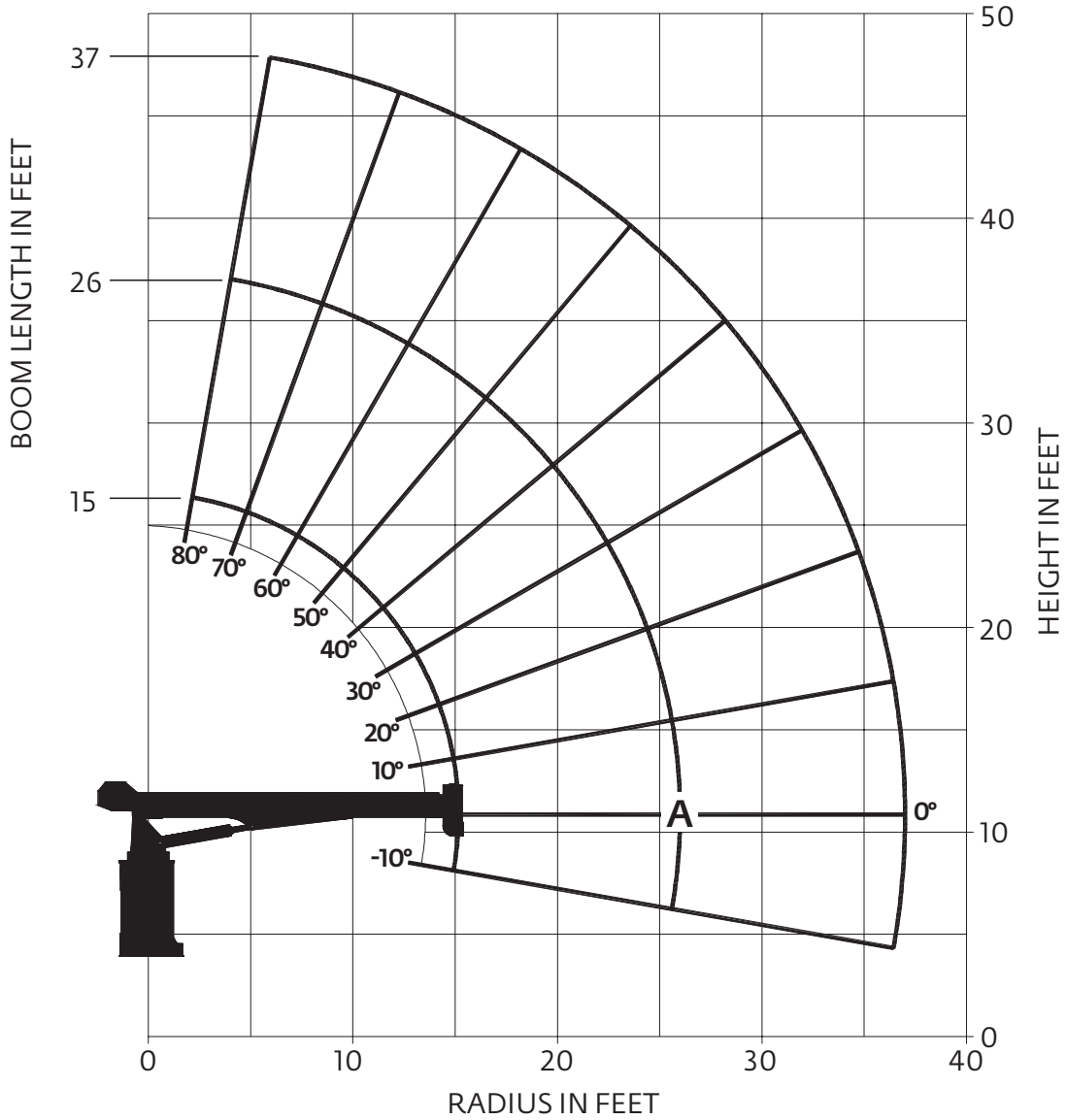

THIS CHART IS ONLY A GUIDE AND SHOULD NOT BE USED TO OPERATE THE CRANE.

The individual crane's load chart, operating instructions and other instructional plates must be read and understood prior to operating the crane.

Load chart



4,62 m - 11,28 m
(15 ft 2 in - 37 ft)



100%
7,52 m
(24.7 ft)



360°



Pounds

LOAD RADIUS (FEET)	LOADED BOOM ANGLE	15 ft BOOM (lb)	LOADED BOOM ANGLE	A 26 ft BOOM (lb)	LOADED BOOM ANGLE	37 ft BOOM (lb)
5	71	20,000				
6	67	16,100	77	14,050		
8	59	13,450	73	11,600		
10	49	11,500	68	9800	76	8800
12	39	10,000	63	8500	72	7800
14	23	8600	58	7650	69	6900
16			53	6950	66	6150
18			47	6400	62	5450
20			41	5750	59	4800
25			18	4500	49	4250
30					38	3600
35					21	3000
	0	6800	0	3600	0	2300

NOTE:

1. All capacities are in pounds, angles in degrees, radius in feet.
2. Loaded boom angles are given as reference only.

THIS CHART IS ONLY A GUIDE AND SHOULD NOT BE USED TO OPERATE THE CRANE.

The individual crane's load chart, operating instructions and other instructional plates must be read and understood prior to operating the crane.

Working range

 14,02 m
(46 ft)

 100%
7,52 m
(24.7 ft)

 360°

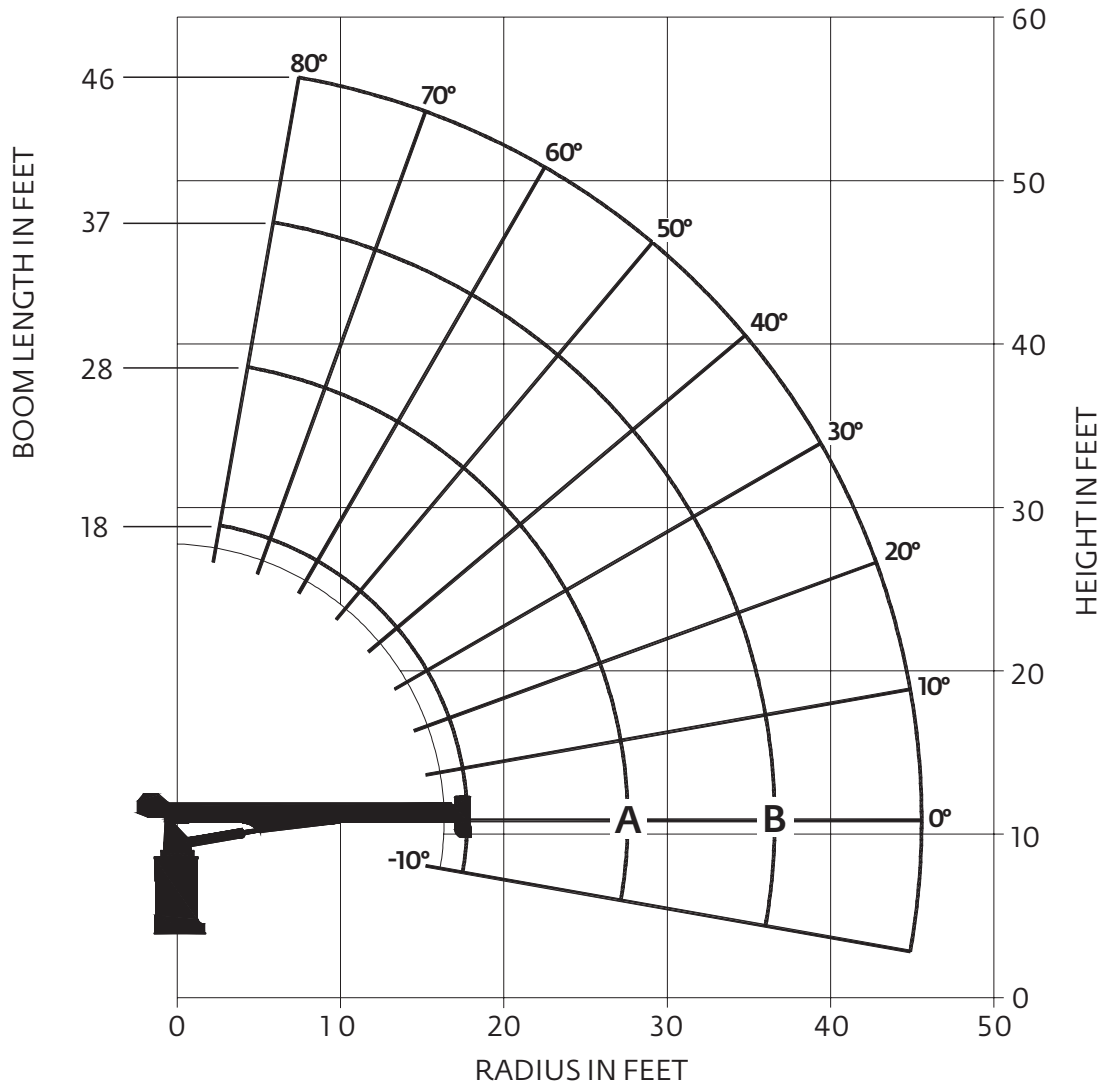

THIS CHART IS ONLY A GUIDE AND SHOULD NOT BE USED TO OPERATE THE CRANE.

The individual crane's load chart, operating instructions and other instructional plates must be read and understood prior to operating the crane.

Load chart

 5,54 m - 14,02 m
(18 ft 2 in - 46 ft)

 100%
7,52 m
(24.7 ft)

 360°



Pounds

LOAD RADIUS (FEET)	LOADED BOOM ANGLE	18 ft BOOM (lb)	LOADED BOOM ANGLE	A 28 ft BOOM (lb)	LOADED BOOM ANGLE	B 37 ft BOOM (lb)	LOADED BOOM ANGLE	46 ft BOOM (lb)
5	74	20,000						
6	71	15,550	78	14,250				
8	64	12,600	74	11,550	78	10,700		
10	56	10,600	70	9550	75	8850		
12	48	9300	65	8150	72	7600	76	6750
14	41	8250	61	7200	69	6750	73	6300
16	27	7050	56	6550	66	6050	71	5450
18			51	6050	63	5450	69	4950
20			46	5450	59	4800	66	4650
25			29	4600	49	4150	59	3850
30					38	3500	51	3450
35					21	2850	42	2900
40							31	2400
45							14	1950
	0	5300	0	3150	0	2200	0	1550

NOTE:

1. All capacities are in pounds, angles in degrees, radius in feet.
2. Loaded boom angles are given as reference only.

THIS CHART IS ONLY A GUIDE AND SHOULD NOT BE USED TO OPERATE THE CRANE.

The individual crane's load chart, operating instructions and other instructional plates must be read and understood prior to operating the crane.

Load charts



17,07 m
(56 ft)



100%
7,52 m
(24.7 ft)



360°

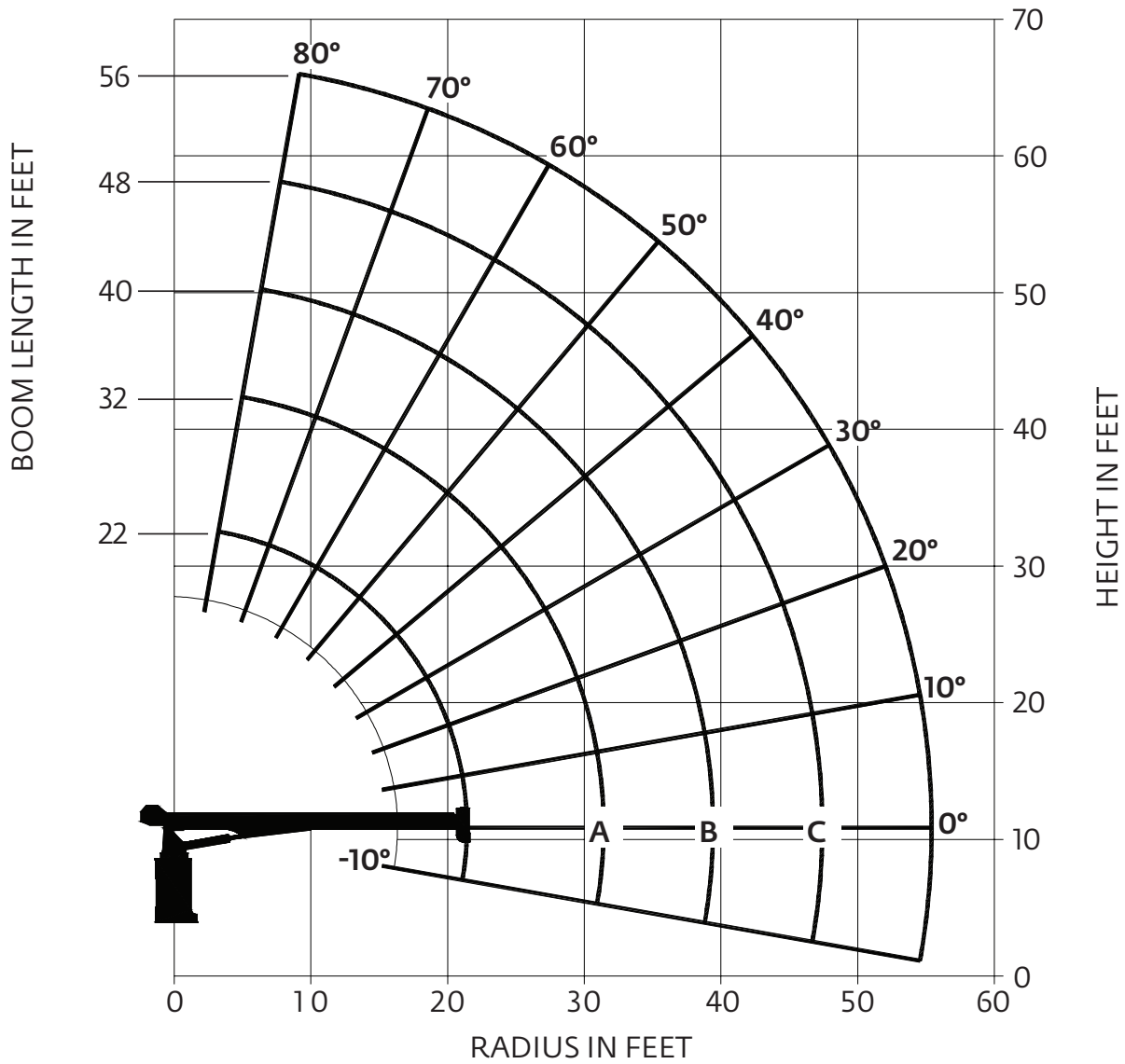

THIS CHART IS ONLY A GUIDE AND SHOULD NOT BE USED TO OPERATE THE CRANE.

The individual crane's load chart, operating instructions and other instructional plates must be read and understood prior to operating the crane.

Load charts



6,55 m - 17,07 m
(21 ft 6 in - 56 ft)



100%
7,52 m
(24.7 ft)



360°



Pounds

LOAD RADIUS (FEET)	LOADED BOOM ANGLE	22 ft BOOM (lb)	LOADED BOOM ANGLE	A 32 ft BOOM (lb)	LOADED BOOM ANGLE	B 40 ft BOOM (lb)	LOADED BOOM ANGLE	C 48 ft BOOM (lb)	LOADED BOOM ANGLE	56 ft BOOM (lb)
5	77.5	20,000								
6	74.5	17,500								
8	70	13,000	76.5	11,100	79.5	10,550				
10	63	10,200	73	9000	77	8800				
12	56.5	9000	69	7800	74	7400	76.5	7250		
14	50	8000	65	7000	70.5	6500	75	6250	77	6000
16	42.5	7100	61	6200	68.5	5800	72.5	5500	75.5	5250
18	34	6300	57.5	5600	65	5300	69.5	5000	73.5	4700
20	23	5600	53	5200	62	4900	67.5	4700	71	4300
25			40.5	4200	53.5	4000	61	3800	65.5	3500
30			22.5	3350	43.5	3300	53.5	3100	60	2900
35					31	2750	45.5	2700	53.5	2500
40							36	2200	46.5	2100
45							22.5	1850	39	1750
50									29	1500
55									13	1150
	0	4250	0	2500	0	1800	0	1350	0	950

NOTE:

1. All capacities are in pounds, angles in degrees, radius in feet.
2. Loaded boom angles are given as reference only.

THIS CHART IS ONLY A GUIDE AND SHOULD NOT BE USED TO OPERATE THE CRANE.

The individual crane's load chart, operating instructions and other instructional plates must be read and understood prior to operating the crane.

Specifications

Super Structure

Boom

Three boom length options: 4,62 m – 11,28 m (15 ft – 37 ft) three-section with a max. tip height of 14,1 m (46.4 ft), 5,54 m – 14,02 m (18 ft – 46 ft) three-section with a max. tip height of 16,9 m (55.3 ft) and a 6,55 m – 17,07 m (21.5 ft – 56 ft) three-section with a max. tip height of 19,8 m (65.1 ft). Proportional extension via multi-stage hydraulic cylinder and cable operation; four-plate, high-strength steel construction; two-sheave, quick reeve boom nose and Easy-glide wear pads.

Boom elevation

One (1) double-acting, hydraulic cylinder with holding valve with a -15° to $+80^{\circ}$

Rated Capacity Limiting (RCL) and anti-two block (ATB) systems

Hydraulic capacity alert (HCA) system to assist the operator in preventing crane overload when making lifts on main boom. This HCA system is a hydraulically operated, maximum capacity sensing device designed to stop all of the normal crane functions that can cause overload when maximum capacity is exceeded on the main boom. Any function that will increase the load radius plus winch up of load is interrupted when maximum capacity is exceeded. Color-coded load range gauge located at each operator station. Two indicator lights provide an alert to the operator of function power loss and distinguish whether the hydraulic capacity alert or anti-two block system is activated. A momentary override key switch for emergency repositioning of boom. Audio visual warning and crane function lockout. Hard-wired ATB circuit routed internally to the boom.

Operator station

Dual-station ASME B30.5 compliant proportional crane controls with mechanical direct-to-valve control of hoist, lift, telescope and swing functions on both the driver and passenger sides of the crane. Mechanical direct-to-valve control of all outrigger functions on both the driver and passenger sides of the crane. HCA system: Color-coded load range gauge located at each operator station; A momentary override key switch for emergency repositioning of boom. Sealed electric switches for control of engine start/stop and horn. Throttle pedal located at each side. Load chart(s) located at each side

Slewing

One (1) Planetary slewing gear with a low speed high torque motor. Integrated holding valves and spring applied, pressure released brake release circuit; 375° , non-continuous rotation; manually adjustable swing speed needle valve.

Hydraulic system

Open-center hydraulics system allowing for multifunction operation of all crane functions. One (1) SAE-BB mounted, tandem section vane pump for all functions and optimized system performance.

Shaft input of 1850 RPM generating:

Section #1 (Hoist): 25 gpm (95 lpm) max flow

Section #2 (All other functions): 12 gpm (45 lpm) max flow

32 gallon (148 L) hydraulic reservoir with SAE o-ring connections and integrated suction shut-off ball valve for easy maintenance and SAE o-ring hydraulic fittings and hoses.

Electrical system

Automotive grade, fully wire harnessed 12VDC electrical system using sealed connectors

Crane functions

Automotive grade, fully wire harnessed 12VDC electrical system using sealed connectors

**Denotes optional equipment.*

Lower



Chassis Mounting

Torsion resistant, high-strength steel sub-frame. Crane frame and sub-frame attached using threaded mounting bolts and drilled and bolted clamp plates for secure attachment to the truck chassis. Rear outriggers attached using Huck® fasteners to both the truck frame and sub-frame to ensure a secure and maintenance-free connection. Rear bumper underride protection standard on factory mounted cranes. Removable rear mounted boom rest fabricated from structural steel



Mounting configurations

Standard Mount: Crane frame located behind the truck cab; Crane frame supported by a torsion resistant sub-frame; A-frame style front outriggers at the crane frame; ASH-style angled cylinder rear outriggers; Full span outriggers load chart operation; Boom stows over rear of truck

Standard Mount w/o sub-frame (torsion box): Crane frame located behind the truck cab; Crane frame mounted directly to the truck chassis frame; A-frame style front outriggers at the crane frame; ASH-style angled cylinder rear outriggers; Full span outriggers load chart operation; Requires a compatible truck specification for stability; Boom stows over rear of truck

Rear Mount: Crane frame located behind the truck cab; Crane frame supported by a torsion resistant sub-frame; A-frame style front outriggers at the crane frame; ASH-style angled cylinder rear outriggers; Full span outriggers load chart operation; Boom stows over rear of truck

Tractor Mount: Crane frame located behind the truck cab on a short wheelbase, fifth wheel equipped truck; Crane frame supported by a torsion resistant sub-frame; A-frame style front outriggers at the crane frame; ASH-style angled cylinder rear outriggers; Full span outriggers load chart operation; Boom stows over rear of truck



Outriggers

Outrigger monitoring system for beam extension standard. Inverted cylinder rods for outrigger jack cylinders to best protection of chromed rod

Optional items

• Outriggers, Sub-frame and Flatbed

- > “Out & Down” style outriggers in lieu of standard for a Standard Mount or Rear Mount crane configuration
- > Single Front Outrigger (SFO) option
- > 14ft (4,3m) and 18ft (5,5m) sub-frame length options
- > Wood and super-duty wood beds

• Hook blocks

- > 4.2 ton (3,8 mt) Overhaul ball for single part line operation
- > Single sheave, 12.5 ton (11,3 mt) quick-reeve hook block for 2 part reeving

• Hydraulics

- > 1-option control circuit

• Operator Aids

- > Four-function wireless radio remote control
- > Dual HCA system
- > Metric capacity charts
- > Spanish documentation and decals

• Personnel platforms

- > One (1) person steel, non-insulated, gravity hung, platform option
- > Capacities up to 250 lbs (113,4 kg) on main boom
- > Basket test weight sets available

**Denotes optional equipment.*

Specifications



Hoist

4627 kg (10,200 lb) planetary gear with a single-speed motor; Integrated motor manifold and spring applied, pressure released brake

Parts of Line	1 part line	2 part line	3 part line
Max boom length (ft) at max elevations with stated rigging and load block and ground level	17,07 m (56 ft)	14,63 m (48 ft)	9,76 m (32 ft)
Lift and speed	3493 kg (7700 lb) 30 m/min (100 fpm)	6985 kg (15,400 lb) 15 m/min (50 fpm)	9075 kg (20,000 lb) 10 m/min (33 fpm)

Line Pulls and Reeving Information			
Hoists	Cable specs.	Permissible line pulls	Nominal cable length
Main	Standard 9/16" diameter rotation resistant Min. Breaking Strength 17 463 kg (38,500 lb)	3493 kg (7700 lb)	67,1 m (220 ft)

The approximate weight of 9/16 in wire rope is 1,04 kg/m (0.70 lb/ft).

*With certain boom and hoist tackle combinations, the allowable line pull may be limited by hoist performance. Refer to Hoist Performance table for lift planning to ensure adequate hoist performance on drum rope layer required.

Hoist Performance			
Wire rope layer	Hoist Line Pull	Line speed	Drum Capacity
1	4627 kg (10,200 lb)	25,0 m /min (82 ft/min)	19,8 m (65 ft)
2	4173 kg (9200 lb)	27,4 m /min (90 ft/min)	41,8 m (137 ft)
3	3799 kg (8375 lb)	30,48 m /min (100 ft/min)	65,8 m (216 ft)

*Refer to Line Pulls and Reeving Information table for max. lifting capacity of wire rope.

Synthetic rope layer height may vary and may reduce available line pull per layer.



































Weight Reductions for Load Handling Devices	
Hook blocks and headache balls	
11,3 t (12.5 USt), 1-sheave	86 kg (190 lb)+
3.6 t (4,2 USt) overhaul ball	43 kg (96 lb)+

+ Refer to rating plate for actual weight

When lifting over boom extension, deduct total weight of all load handling devices reeved over main boom nose directly from boom extension capacity.

NOTE: All load handling devices and boom attachments are considered part of the load and suitable allowances MUST BE MADE for their combined weights. Weights are for Manitowoc furnished equipment.

Symbols glossary

 Axles	 Drive	 Heavy duty jib	 Radius
 Boom	 Electrical system	 Hoist	 Rotation
 Boom elevation	 Engine	 Hookblock	 Speed
 Boom extension	 Extension	 Hydraulic system	 Steering
 Boom length	 Frame	 Insert	 Suspension
 Boom nose	 Fuel tank capacity	 Lights	 Swing
 Brakes	 Gear	 Oil	 Tires
 Operators station	 Grade	 Outrigger controls	 Transmission
 Counterweight	 Height (no max)	 Outriggers	

Notes

Manitowoc Cranes

Regional headquarters

Americas

Manitowoc, Wisconsin, USA

Tel: +920 684 4410

Fax: +1 920 652 9778

Shady Grove, Pennsylvania, USA

Tel: +1 717 597 8121

Fax: +1 717 597 4062

Europe and Africa

Dardilly, France - TOWERS

Tel: +33 (0)4 72 18 20 20

Fax: +33 (0)4 72 18 20 00

Wilhelmshaven, Germany - MOBILE

Tel: +49 (0) 4421 294 0

Fax: +49 (0) 4421 294 4301

China

Shanghai, China

Tel: +86 21 6457 0066

Fax: +86 21 6457 4955

Middle East and Greater Asia-Pacific

Singapore

Tel: +65 6264 1188

Fax: +65 6862 4040

Dubai, UAE

Tel: +971 4 8862677

Fax: +971 4 8862678/79



This document is non-contractual. Constant improvement and engineering progress make it necessary that we reserve the right to make specification, equipment, and price changes without notice. Illustrations shown may include optional equipment and accessories and may not include all standard equipment.