

SANY

HYDRAULIC EXCAVATOR SY60C

Engine **KUBOTA V2607**
Power **45 KW/2200 RPM**
Operating Weight **5780 KG**
Ground Pressure **32,75 KPA**



- RELIABLE FIRST-CLASS COMPONENTS
- LOWER FUEL CONSUMPTION
- SIMPLIFIED SERVICE

SPECIFICATIONS

| ENGINE | |
|---|----------|
| Model | V2607 |
| Displacement (L) | 2,615 |
| Engine power at rated engine speed (kW/rpm) | 45/2200 |
| Max. Torque (N · m/rpm) | 225/1500 |

| SERVICE REFILL CAPACITIES (L) | |
|-------------------------------|-----|
| Fuel tank | 130 |
| Engine coolant | 5,6 |
| Engine oil | 9,6 |
| Swing drive | / |
| Final drive (each side) | 0,9 |
| Hydraulic oil tank | 85 |

| HYDRAULIC SYSTEM | |
|--|---|
| Typ | load sensing system |
| Number of selectable working modes | 3 |
| Main pump | |
| Typ | Variable-capacity piston pump |
| Maximum flow (L/min) | 149 |
| Hydraulic motors | |
| Travel | 2*axial piston motor with parking brake |
| Swing | 1*axial piston motor with swing holding brake |
| Relief valve setting | |
| Implement circuits (MPa) | 24,5 |
| Travel circuit (MPa) | 24,5 |
| Swing circuit (MPa) | 18,6 |
| Heavy lift circuit (MPa) | / |
| Pilot circuit (MPa) | 3,5 |
| Hydraulic cylinders | |
| Boom cylinder diameter x stroke (mm) | 115x710 |
| Arm cylinder diameter x stroke (mm) | 90x815 |
| Bucket cylinder diameter x stroke (mm) | 85x605 |
| Blade cylinder diameter x stroke (mm) | 120x150 |









| OPERATING WEIGHT | |
|--|-------|
| Operating weight with standard bucket, fully serviced, +75 kg operator (ISO) | |
| Operating weight (kg) | 5780 |
| Ground Pressure (kPa) | 32,75 |

| DRIVE | |
|--------------------------------|-----------|
| Travel Speed (Low/High) (km/h) | 3,73/2,40 |
| Maximum Travel Force (kN) | 47,2 |
| Gradeability | 35° |

| SWING | |
|-------------------|-----|
| Swing Speed (rpm) | 9,6 |

| DIGGING FORCE | |
|---------------------------|----|
| Bucket Digging Force (kN) | 45 |
| Arm Digging Force (kN) | 33 |

LIFTING CAPACITY

| A \ B | MAX | | 2.0m | | 3.0m | | 4.0m | | 5.0m | | |
|----------|---------|---|---|---|---|---|---|---|---|---|------|
| | Maximum |  |  |  |  |  |  |  |  |  | |
| 4m (kg) | 1050 | | | | | | 1100 | 1100 | 1100 | | |
| 3m (kg) | 850 | *1200 | | | | | 1100 | 1100 | *1150 | | |
| 2m (kg) | 750 | *1250 | | | 1600 | 1800 | 1050 | 1050 | *1400 | 750 | 1250 |
| 1m (kg) | 700 | 1300 | | | 1500 | *2400 | 1000 | 1000 | 1650 | 750 | 1350 |
| 0m (kg) | 750 | 1400 | | | 1400 | 2650 | 1000 | 1000 | 1800 | 750 | 1400 |
| -1m (kg) | 800 | 1500 | 2650 | 3750 | 1400 | 2600 | 950 | 950 | 1800 | | |
| -2m (kg) | 1050 | 1600 | | 3550 | 1450 | 2200 | | | | | |

DIMENSIONS

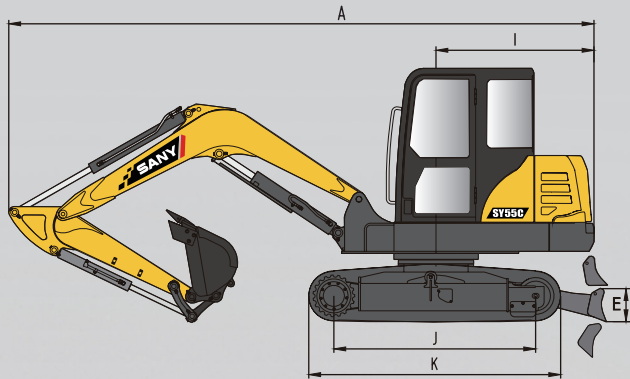
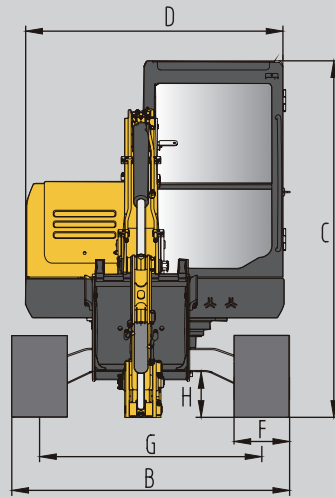

| ITEM | mm |
|------------------------------|------|
| A Transport Length | 5925 |
| B Transport Width | 2005 |
| C Transport Height | 2830 |
| D Upperstructure Width | 1860 |
| E Blade Height | 340 |
| F Standard Track Shoe Width | 400 |
| G Track Gauge | 1600 |
| H Minimum Ground Clearance | 330 |
| I Tail Swing Radius | 1640 |
| J Center distance of tumbler | 2045 |
| K Overall length of crawler | 2545 |
| Counterweight Clearance | 705 |
| Boom Length | 3000 |
| Arm Length | 1700 |

| UNDERCARRIAGE | |
|----------------------------------|----------------|
| Track shoe width (mm) | 400 |
| Number of track shoes (per side) | Rubber crawler |
| Carrier roller (per side) | 1 |
| Track roller (per side) | 5 |

| ITEM | mm |
|--------------------------------|------|
| A Max. Digging Height | 5705 |
| B Max. Dumping Height | 3945 |
| C Max. Digging Depth | 3830 |
| D Max. Vertical Digging depth | 3085 |
| E Max. Digging Reach | 6110 |
| F Min. Swing Radius | 2555 |
| G Height at Min. Swing Radius | 4495 |
| H Max. Clearance when Blade up | 385 |
| I Max. Depth of Blade down | 380 |

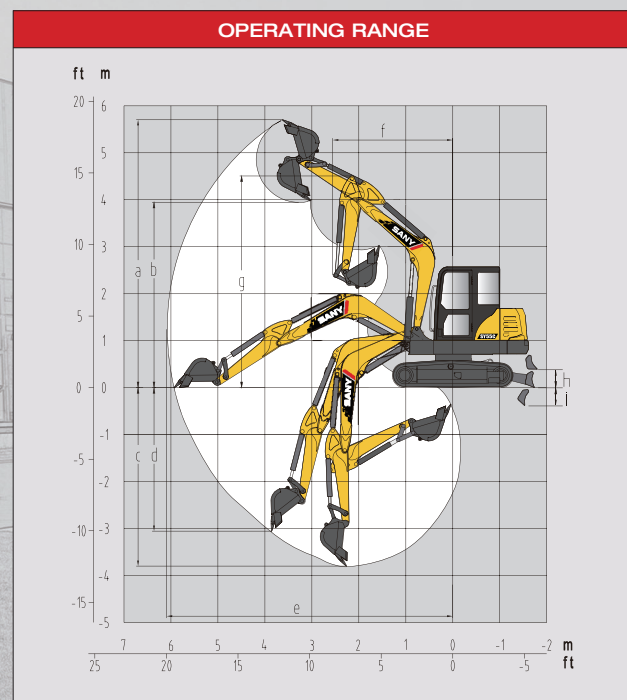

QUALITY CHANGES THE WORLD

Not all products are available in all markets. Under our policy of continuous improvement, we reserve the right to change specifications and design without prior notice. The illustrations do not necessarily show the standard version of the machine.

SANY

**ADDR SANY EUROPE GMBH
SANY ALLEE 1, D-50181 BEDBURG**

TEL 0049 2272 90531 100

FAX 0049 2272 90531 109

MAIL info@sanyeurope.com

NET www.sanyeurope.com



facebook.com/sanyeurope