





Dynapac CA255PD

Single drum vibratory rollers



Technical data

 Masses	
Module mass (front/rear)	/4,250 kg
 Dimensions	
Drum width	2,130 mm
Drum diameter	1,523 mm
Length	5,550 mm
Width	2,324 mm
 Traction	
Vertical oscillation	±9°
Tyre size (8 ply)	23.1 x 26
 Compaction	
Nominal amplitude (high/low)	1.7/0.8 mm
Vibration frequency (high/low amplitude)	33/33 Hz
Centrifugal force (high/low amplitude)	246/119 kN

 Engine	
Manufacturer/Model	Kirloskar 4R1040TA3
Type	Turbocharged + Intercooler, Tier III diesel
Rated power, SAE J1995	77.2 kW (105 hp) @ 2,200 rpm
Fuel tank capacity	250 l

 Hydraulic system	
Driving	Axial piston pump with variable displacement / Axial piston motor with constant displacement + Axial piston motor with variable displacement (D)
Vibration	Axial piston pump with variable displacement / Axial piston motor with constant displacement (D)
Steering	Gear pump with constant displacement.
Service brake	Hydrostatic in forward and reverse lever.
Parking/ Emergency brake	Failsafe multidisc brake in rear axle.

Find us locally at www.atlascopco.com

We reserve the right to change specifications without notice. Photos and illustrations do not always show standard versions of machines. The above information is a general description only, all informations are supplied without liability.

rce_ca255pd_en-20130930.140234.pdf 2013-09-30 14:02

Dynapac CA255PD

Single drum vibratory rollers

Atlas Copco

Technical data

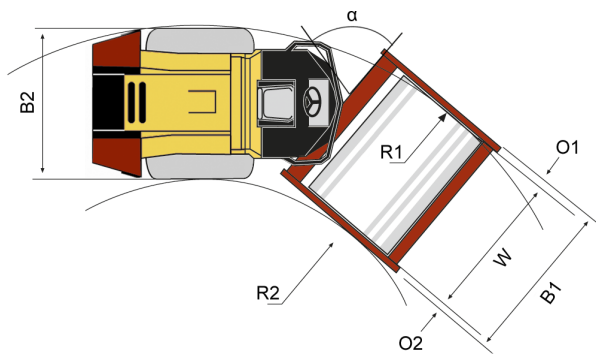
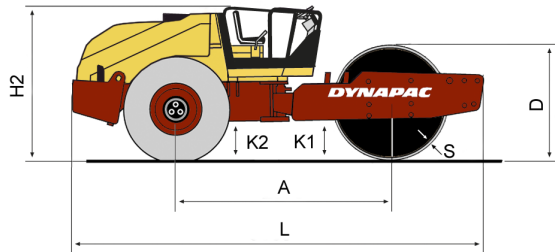

Dimensions	
A. Wheelbase	2,870 mm
B1. Width, front	2,324 mm
B2. Width, rear	2,130 mm
D. Drum diameter	1,523 mm
H2. Height, w/o ROPS/cab	0 mm
K1. Ground clearance	453 mm
K2. Curb clearance	400 mm
L. Length	5,550 mm
O1. Overhang, right	107 mm
O2. Overhang, left	107 mm
R1. Turning radius, outside	5,400 mm
R2. Turning radius, inside	3,100 mm
S. Drum shell thickness	25 mm
W. Drum width	2,130 mm
α . Steering angle	$\pm 38^\circ$

Find us locally at www.atlascopco.com

We reserve the right to change specifications without notice. Photos and illustrations do not always show standard versions of machines. The above information is a general description only, all informations are supplied without liability.

rce_ca255pd_en-20130930.140234.pdf 2013-09-30 14:02