



Dynapac SD2530CS

Large pavers





Technical data

 Masses	
Weight	19.20 t

 Dimensions	
Basic width	2.55 m
Working width, max.	10 m
Working width, minimum (with reducing shoe)	2.05 m
Front ramp angle	13°

 Capacity	
Placement thickness (max)	360 mm
Theoretical placement capacity	800 t/h

 Material hopper	
Capacity	7.0 m ³ (17 t)
Dumping height (center/outside)	525 mm /530 mm
Hopper width, internal	3292 mm

 Traction	
Paving speed	Up to 20 m/min
Transport speed	3.0 km/h

 Engine	
Emissions according to	Stage IIIA (Tier 3)
Rated power, SAE J1995	142 kW (193 hp) @ 2200 rpm with stepless rpm control and ECO-mode
Electrical system	24 V
Fuel tank capacity	320 l

 Undercarriage	
Crawler length	3360 mm
Crawler width	320 mm

 Conveyor	
Conveyor type	Dual bar feeder
Conveyor control	Automatic with limit switches
Conveyor width	2x 655 mm

 Auger	
Auger diameter	380 mm
Auger control	Automatic with ultrasonic sensors

Find us locally at www.dynapac.com

We reserve the right to change specifications without notice. Photos and illustrations do not always show standard versions of machines. The above information is a general description only, all informations are supplied without liability.

Dynapac SD2530CS

Large pavers



Technical data

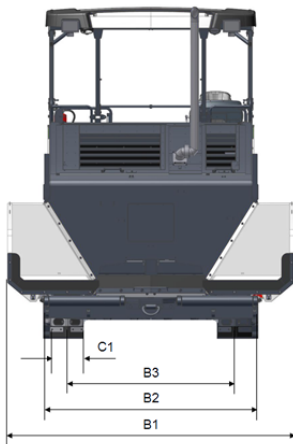
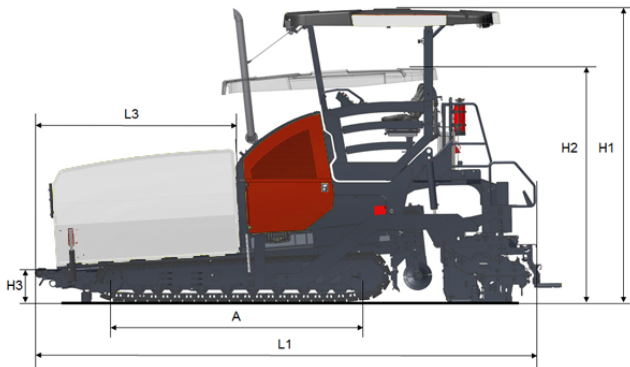

Dimensions	
A. Axle track	3360 mm
B1. Width, max.	3460 mm
B2. Width, standard	2550 mm
B3. Width, center of tracks	1992 mm
C1. Track width	320 mm
H1. Height, max.	3900 mm
H2. Height, transport	3100 mm
H3. Height	463 mm
L1. Length	6625 mm
L3. Length, hopper	2604 mm

Suitable screeds					
Model	Basic width	Working width, hydraulic extendable	Working width, max.	Compacting elements	Heating system
V6000TV	3.00 m	6.00 m	9.70 m	Vertical impact tamper /Vibration	Propane (LPG)
V6000TVE	3.00 m	6.00 m	9.70 m	Vertical impact tamper /Vibration	Electrical
R300TVE	3.00 m	N/A	14.00 m	Vertical stroke tamper/vibration	Electrical
R300TV	3.00 m	N/A	14.00 m	Vertical stroke tamper/vibration	Propane (LPG)

Find us locally at www.dynapac.com

We reserve the right to change specifications without notice. Photos and illustrations do not always show standard versions of machines. The above information is a general description only, all informations are supplied without liability.