







Dynapac F2500W

Large pavers





Technical data

 Masses	
Weight (incl. standard screed)	17.50 t
 Dimensions	
Basic width	2.55 m
Working width, max.	6.60 m
Working width, minimum (with reducing shoe)	2.05 m
Front ramp angle	17°
 Capacity	
Placement thickness (max)	300 mm
Theoretical placement capacity	650 t/h
 Material hopper	
Capacity	6.0 m ³
Dumping height (center/outside)	574 mm /587 mm
Hopper width, internal	3142 mm
 Traction	
Maximum paving speed	30 m/min
Transport speed	15.0 km/h

 Engine	
Manufacturer/Model	Cummins QSB 6.7-C173
Emissions according to	Stage IIIA (Tier 3)
Rated power	110 kW @ 2200 rpm
Electrical system	24V
Fuel tank capacity	315 l

 Undercarriage	
Final drive	Direct drive over transmissions
Tyre size	445/80R25
Front wheels	4 x 560/300-390
Wheel drive	2 rear wheels
Turning radius (inside)	2477 mm
Turning radius (outside)	6065 mm

 Conveyor	
Conveyor type	Dual bar feeder
Conveyor width	2 x 580 mm
Conveyor control	The independent conveyor with proportional control

 Auger	
Auger diameter	380 mm
Auger control	Automatic with ultrasonic sensors

Find us locally at www.dynapac.com

We reserve the right to change specifications without notice. Photos and illustrations do not always show standard versions of machines. The above information is a general description only, all informations are supplied without liability.

Dynapac F2500W

Large pavers



Technical data

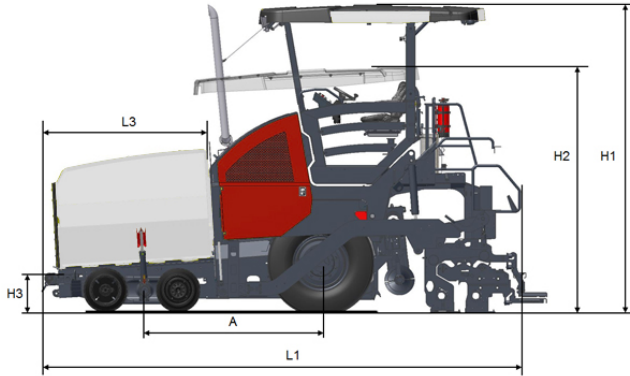

Dimensions	
A. Wheelbase	2,241 mm
B1. Width, max.	3,250 mm
B2. Width, standard	2,550 mm
B3. Width, wheel track	2,053 mm
H1. Height, max.	3,900 mm
H2. Height, transport	3,100 mm
H3. Height	493 mm
L1. Length	6,100 mm
L3. Length, hopper	2,123 mm

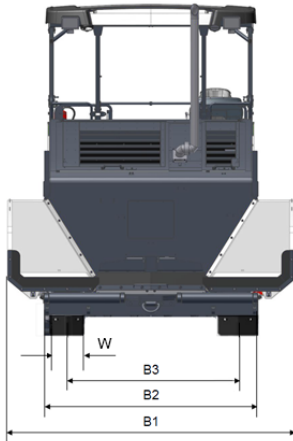

Find us locally at www.dynapac.com

We reserve the right to change specifications without notice. Photos and illustrations do not always show standard versions of machines. The above information is a general description only, all informations are supplied without liability.